

Signal Conditioners: microBlox® Series

Acromag Agility™ Config Tool Mobile Application

The Agility™ Config Tool is a mobile application that allows easy setup and configuration of Acromag microBlox® Series signal conditioners and alarms.

You can download the Agility application free of charge from the Google Play™ store at play.google.com (Android), or the Apple® App Store® at itunes.apple.com (Apple iOS).

Demo the software, no need for a module. To enter demo mode simply tap the  icon in the upper left corner 8 times.

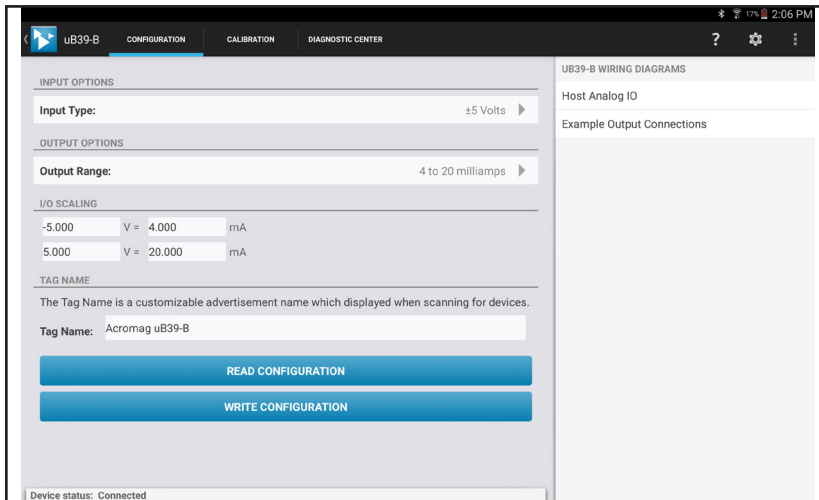
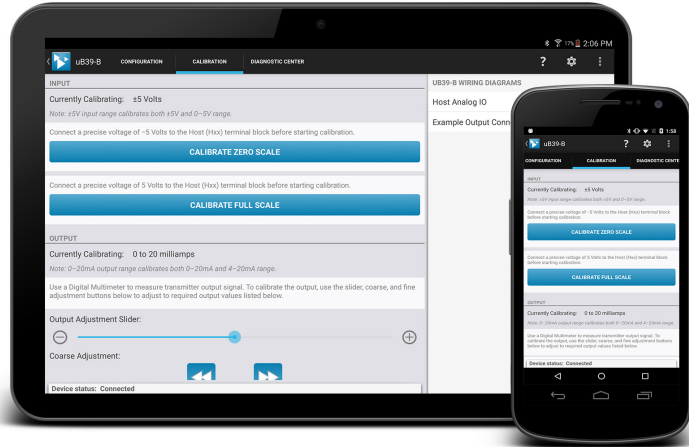

With a couple of taps, quickly configure input, output, unit and scaling options.

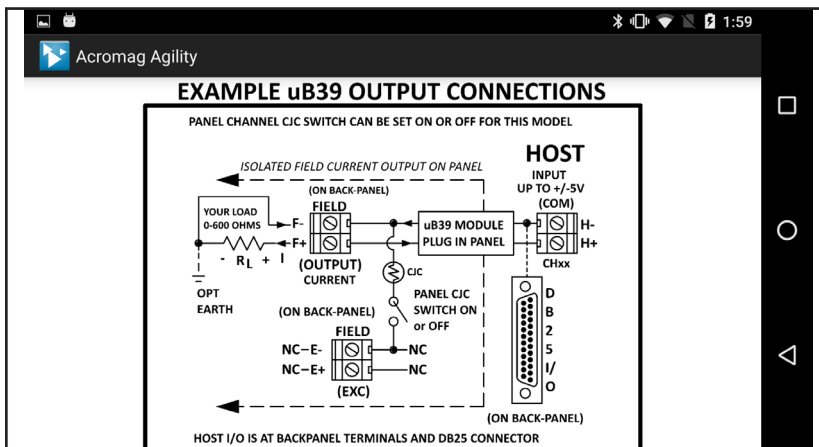

Quick and easy access to the wiring diagram, even offline without internet access.

Key Features & Benefits

- Connects to microBlox signal conditioners via Bluetooth wireless technology
- Requires the use of a smart device
- Configures and calibrates microBlox UB Series products via phone or tablet running Android 4.3 or later or iOS 8.1 or later.
- View wiring diagrams, even without an internet connection
- Perform quick and easy field diagnostics and troubleshooting
- Ideal for field technicians
- Trend and share field data



Signal Conditioners: microBlox™ Series

Acromag Agility™ Config Tool Mobile Application

Alarm Function

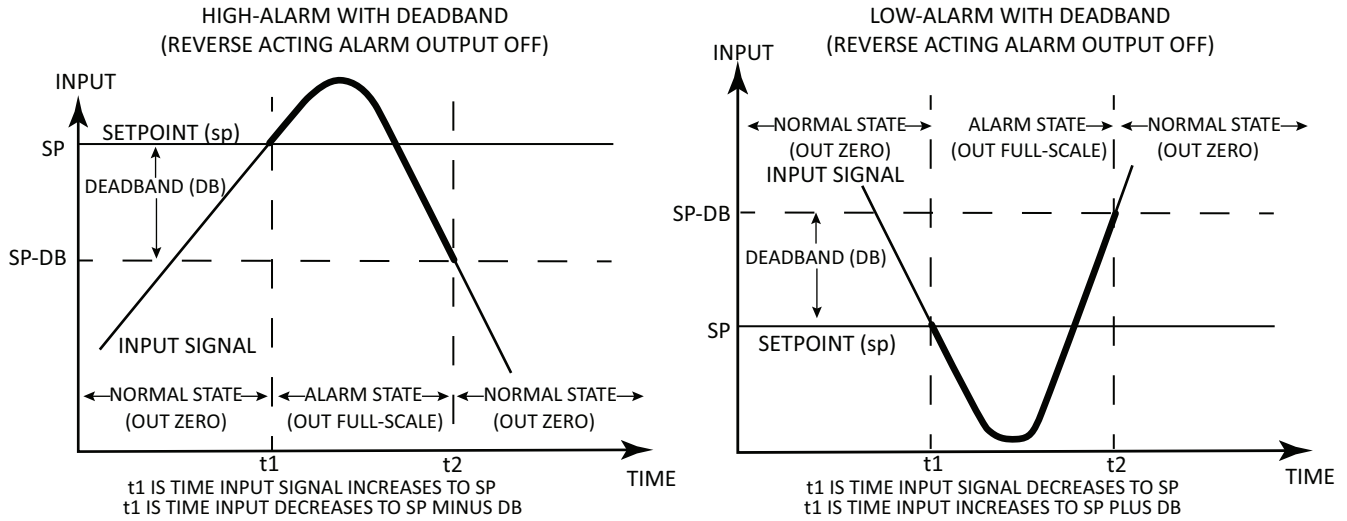

Calibration

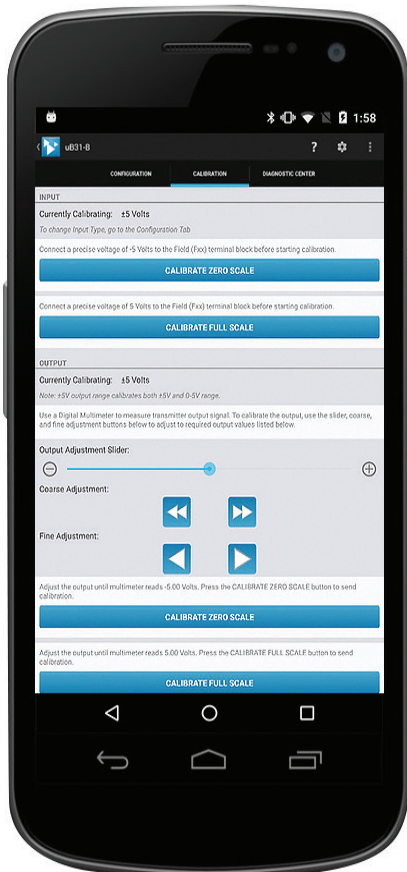

Data Logging



Diagnostics

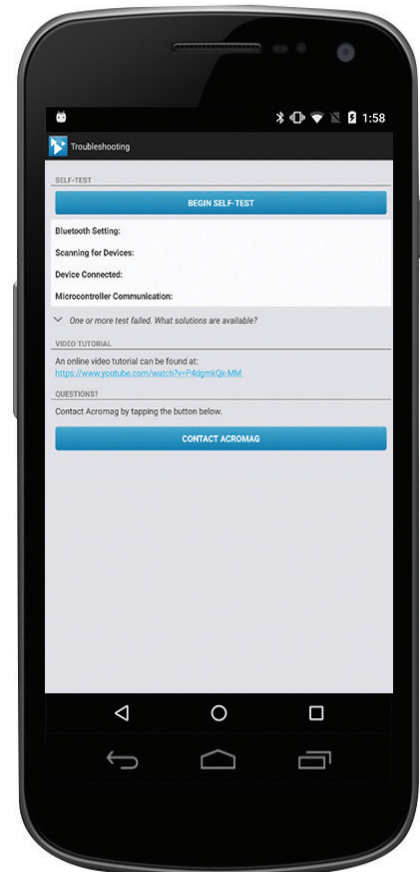

Tel 248-295-0880 ■ sales@acromag.com ■ www.acromag.com ■ 30765 Wixom Rd, Wixom, MI 48393 USA