



BusWorks® 900EN Series – Modbus TCP/IP 10/100M Industrial Ethernet I/O Modules

Model 961EN-4006 Six Differential Current Inputs
Model 962EN-4006 Six Differential Voltage Inputs

USER'S MANUAL



ACROMAG INCORPORATED
30765 South Wixom Road
Wixom, MI 48393-2417 U.S.A.

Tel: (248) 295-0880
Fax: (248) 624-9234

Copyright 2003-2014, Acromag, Inc., Printed in the USA.
Data and specifications are subject to change without notice.

8500720K

TABLE OF CONTENTS

Symbols on equipment:



Means "Refer to User's Manual (this manual) for additional information".

The information of this manual may change without notice. Acromag makes no warranty of any kind with regard to this material, including, but not limited to, the implied warranties of merchantability and fitness for a particular purpose. Further, Acromag assumes no responsibility for any errors that may appear in this manual and makes no commitment to update, or keep current, the information contained in this manual. No part of this manual may be copied or reproduced in any form without the prior written consent of Acromag, Inc.

For additional information, please visit our web site at www.acromag.com and download our whitepaper 8500-765, Introduction To Modbus TCP/IP, or 8500-648, Introduction to Modbus.

Windows® is a registered trademark of Microsoft Corporation.

IMPORTANT SAFETY CONSIDERATIONS

You must consider the possible negative effects of power, wiring, sensor, component, or software failure in the design of any type of monitoring or control system. This is very important where property loss or human life is involved. It is important that you perform satisfactory overall system design and it is agreed between you and Acromag, that this is your responsibility.

GETTING STARTED

MOUNTING AND DIMENSIONS	3
CONTROLS & INDICATORS	3
ISOLATION BARRIERS	3
CONNECTIONS	4
DIN-Rail Mounting And Removal	4
Network	4
Power	6
Analog Inputs	6
Earth Ground	7
WEB BROWSER	8
Home Page	8
Password Configuration Page	9
Network Configuration Page	9
I/O Mapping Page (Optional i2o Function)	12
Test Page	13
Calibration Page	15
Input Calibration	16
TROUBLESHOOTING	17
Diagnostics Table	17
Trouble Browsing Your Module?	18
Getting Out Of Trouble	18

TECHNICAL REFERENCE

KEY FEATURES	19
HOW IT WORKS	20
ABOUT MODBUS TCP/IP	21
IP Addressing	21
Dynamic Host Configuration Protocol	23
Domain Name System (DNS)	23
MODBUS REGISTERS	23
Register Functions	23
Register Mirroring	24
Data Types	25
Register Map	26
SPECIFICATIONS	34
Model Numbers	34
Analog Inputs	34
General Specifications	35
Enclosure and Physical	36
Agency Approvals	36
Environmental	37
Ethernet Interface	38
Controls & Indicators	39
ACCESSORY CABLES	39
REVISION HISTORY	41

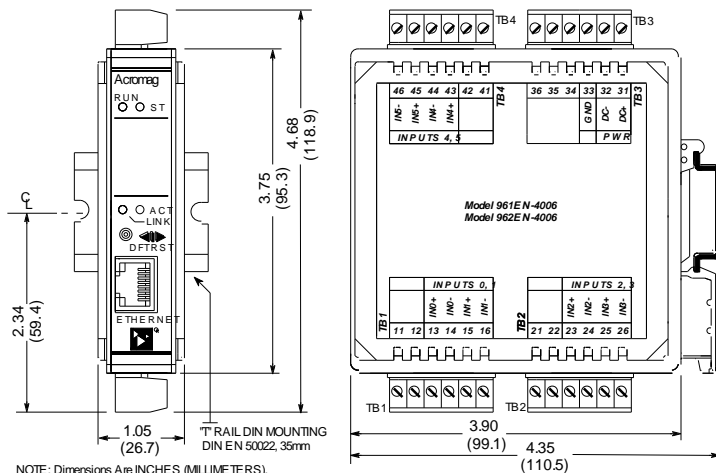

NOTE: Dimensions Are INCHES (MILLIMETERS).

MODEL 961/962EN ENCLOSURE DIMENSIONS

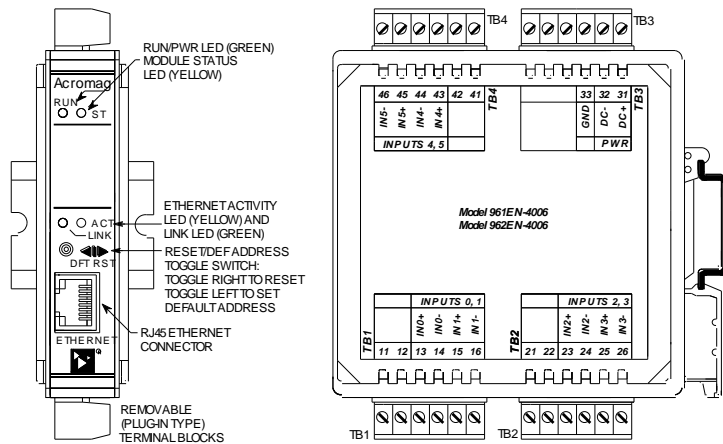

The toggle switch is used to toggle the module into or out of Default Mode (toggle left), or to reset the module (toggle right). In Default Communication Mode, the yellow ST LED blinks slowly and the module assumes a fixed static IP address of "128.1.1.100", a default subnet mask of "255.255.255.0", a default username of "User", and a default password of "password00".

MOUNTING AND DIMENSIONS

Unit mounts to "T" type DIN rails (35mm, type EN50022).

Units may be mounted side-by-side on 1-inch centers.

WARNING: IEC Safety Standards may require that this device be mounted within an approved metal enclosure or sub-system, particularly for applications with exposure to voltages greater than or equal to 75VDC or 50VAC.

CONTROLS & INDICATORS

Green Run LED is ON if power is on and will blink in "wink" ID mode.

Yellow ST LED blinks ON/OFF if module is in default mode and stays ON if an input is out of range.

Green LINK LED ON if auto-negotiation has successfully established a connection.

Yellow ACT LED signals PHY network Activity (busy).

ISOLATION BARRIERS

Dashed Lines denote isolation barriers.

The input circuit, network, and power circuit are isolated from each other for safety and noise immunity.

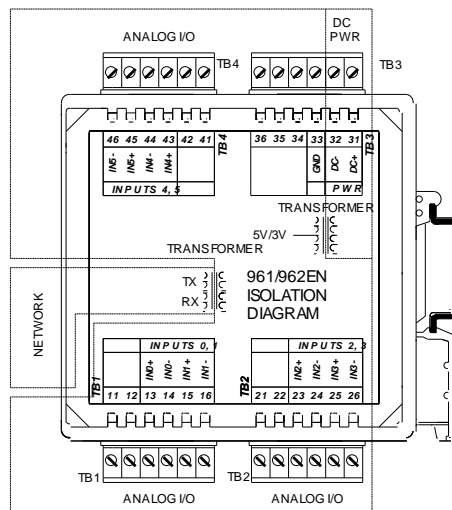

CONNECTIONS

DIN-Rail Mounting & Removal

When attaching the module to the T-type DIN rail, angle the top of the unit towards the rail and locate the top groove of the adapter over the upper lip of the rail. Firmly push the unit towards the rail until it snaps into place. To remove, first separate the input terminal block(s) from the bottom side of the module to create a clearance to the DIN mounting area. Next, while holding the module in place from above, insert a screwdriver into the lower arm of the DIN rail connector and use it as a lever to force the connector down until the unit disengages from the rail (do not twist the screwdriver to avoid damaging plastic).

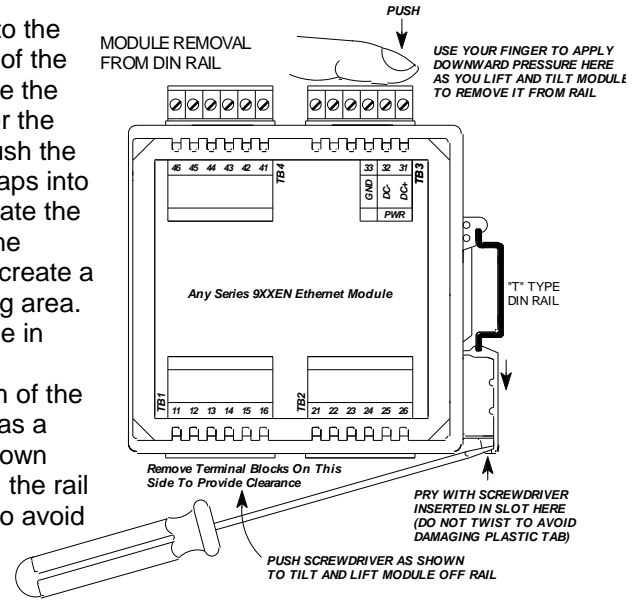

Network

For 100Base-TX systems, use data grade Unshielded Twisted-Pair (UTP) wiring that has a 100Ω characteristic impedance and meets the EIA/TIA Category Five wire specifications.

It is recommended that you use a crossover CAT-5 cable to connect this device to your PC.

For 10Base-T systems, you may use Category 3, Category 4, or Category 5 UTP cable.

In either case, you are limited to 100 meters between any two devices.

A crossover cable simply connects the differential transmit pair on each end, to the receive pair on the opposite end.

Use a standard (direct) cable when connecting to a hub or switch port, which are generally wired MDI-X.

RJ45 MDI AND MDI-X CONNECTIONS

PIN	MDI WIRING	MDI-X WIRING
1	Transmit +	Receive +
2	Transmit -	Receive -
3	Receive +	Transmit +
4	Not Used	Not Used
5	Not Used	Not Used
6	Receive -	Transmit -
7	Not Used	Not Used
8	Not Used	Not Used

Note Crossover Connections

RECOMMENDED CABLE

SPEED	DISTANCE	CABLE
10Base-T	100M	CAT 3, CAT 4, or CAT 5 UTP
100Base-T	100M	CAT 5/5e UTP/STP

ETHERNET PORT

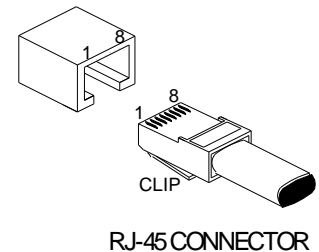

The Ethernet port of this module is wired MDI and does not include automatic crossover. The Ethernet port of your PC is also wired MDI and may not include automatic crossover. As such, you must use a crossover cable like that shown below when connecting this device directly to a PC.

CROSSOVER CABLE FOR MDI TO MDI OR MDI-X TO MDI-X

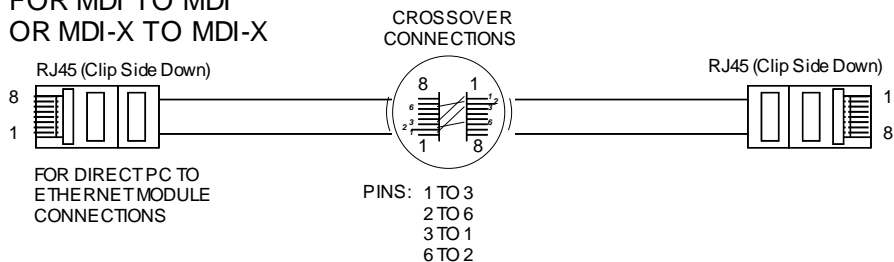

Refer to the section “Cable Accessories” at the back of this manual for more information on accessory cables including patch and crossover cables available from Acromag and other vendors.

CONNECTIONS

Network

TIP: You can significantly enhance the EMI/RFI performance of your network connections by using Category 5E STP cable (Shielded Twisted Pair) with shielded RJ45 plug connectors. This will also help to protect your installation from damage due to ESD (Electro-Static Discharge). The use of shielded cable is strongly recommended for installations in harsh industrial environments and/or in the presence of strong electrical fields.

HOST PC CONNECTED DIRECTLY TO A MODULE

Note: This MDI-to-MDI connection requires the use of a crossover cable.

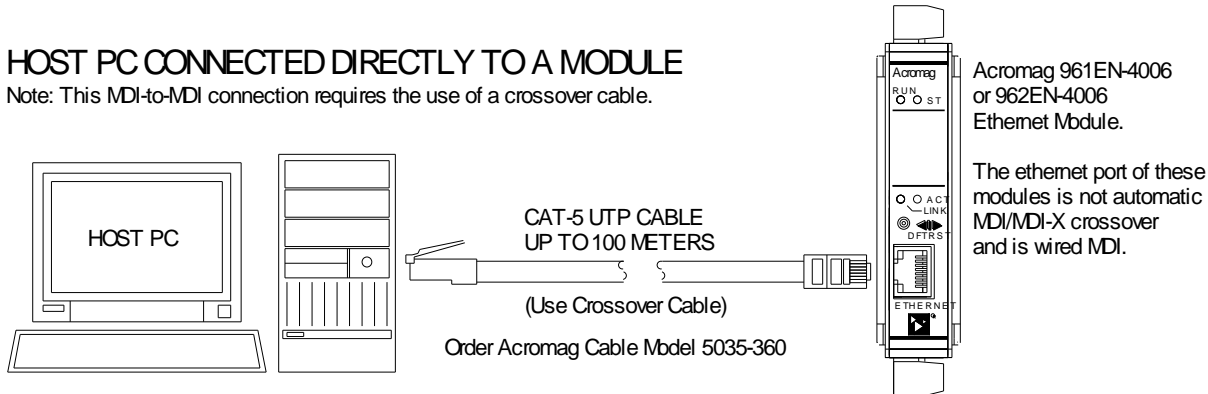

You can use an Ethernet switch or switching hub to build a network of Ethernet modules, similar to that shown below. This drawing shows how to network-connect Acromag Series 9xxEN modules to a 5-port Ethernet switch (Acromag Model 900EN-S005). Note that the 900EN-S005 switch includes automatic MDI/MDI-X crossover and a straight-through or crossover cable(s) may be used to connect to the modules and the PC.

USE OF AN ETHERNET SWITCH TO NETWORK A HOST PC TO MORE THAN ONE MODULE

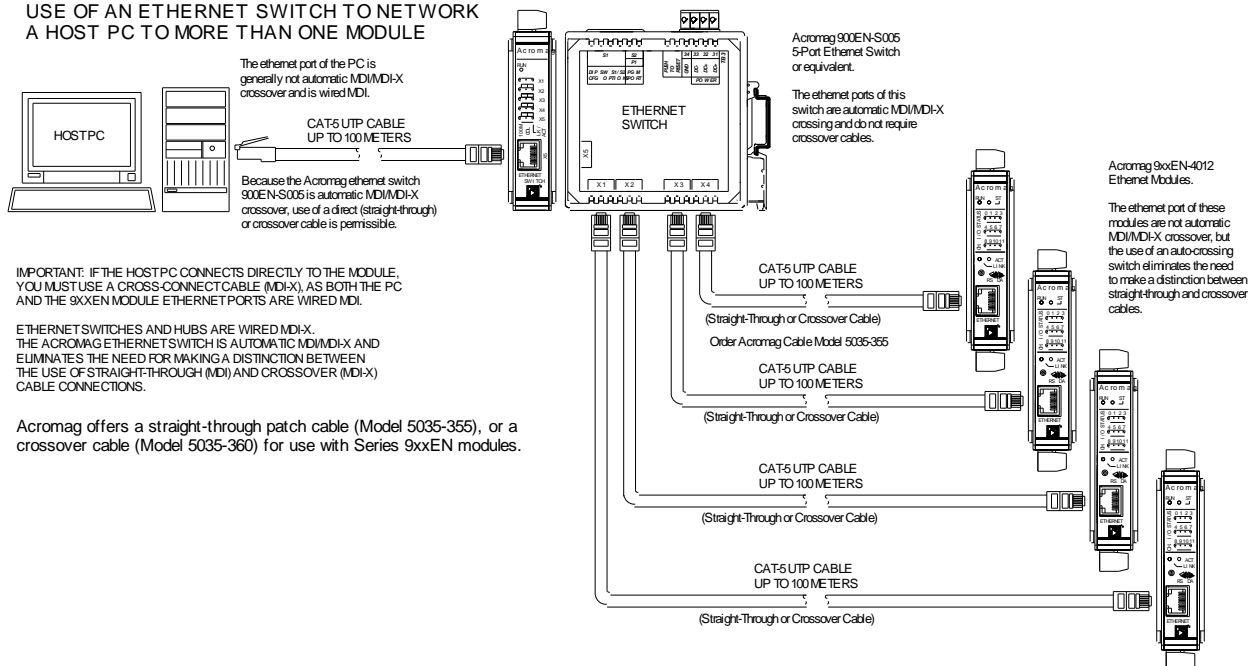

CONNECTIONS

Power

Voltage	Current
15VDC	113mA
18VDC	95mA
24VDC	74mA
36VDC	55mA

- ✓ Connect 15-36V DC to the power terminals labeled DC+ & DC-. Observe proper polarity. For supply connections, use No. 14 AWG wires rated for at least 75°C. **CAUTION:** Do not exceed 36VDC peak.

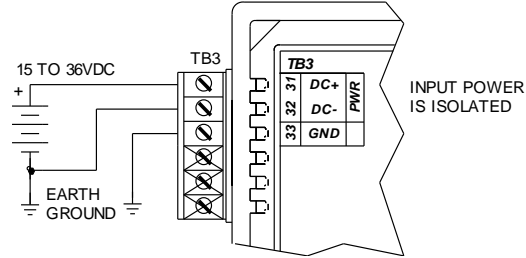

CAUTION: Risk of Electric Shock – More than one disconnect switch may be required to de-energize equipment before servicing.

IMPORTANT – External Fuse: If unit is powered from a supply capable of delivering more than 1A to the unit, it is recommended that this current be limited via a high surge tolerant fuse rated for a maximum current of 1A or less (for example, see Bel Fuse MJS1).

Analog Inputs

Input is DC current (961EN), or DC voltage (962EN), according to model number.

Inputs are not isolated channel-to-channel, except for small common mode voltage differences up to ±12V peak (962EN), or ±5V peak (961EN).

- ✓ Connect analog input signals to the input terminals as shown below according to your model.

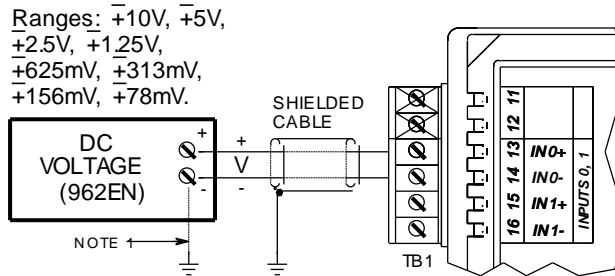
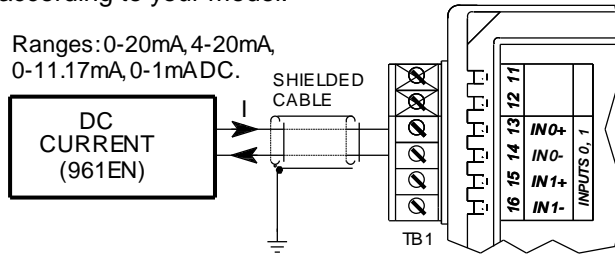

NOTE 1: THIS GROUND CONNECTION IS RECOMMENDED FOR BEST RESULTS. IF SENSORS ARE INHERENTLY CONNECTED TO GROUND, USE CAUTION AND AVOID MAKING ADDITIONAL GROUND CONNECTIONS WHICH COULD GENERATE GROUND LOOPS AND MEASUREMENT ERROR

Connections to an optional AC current sensor or two-wire transmitter (961EN Only)

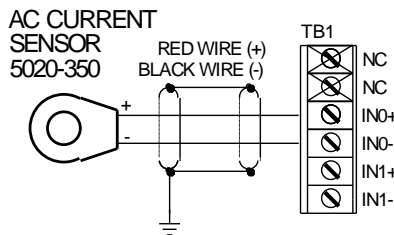

AC CURRENT SENSOR INPUT (961EN)

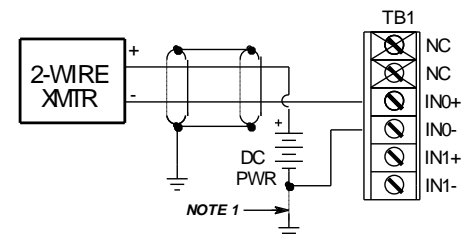

2-WIRE TRANSMITTER (961EN)

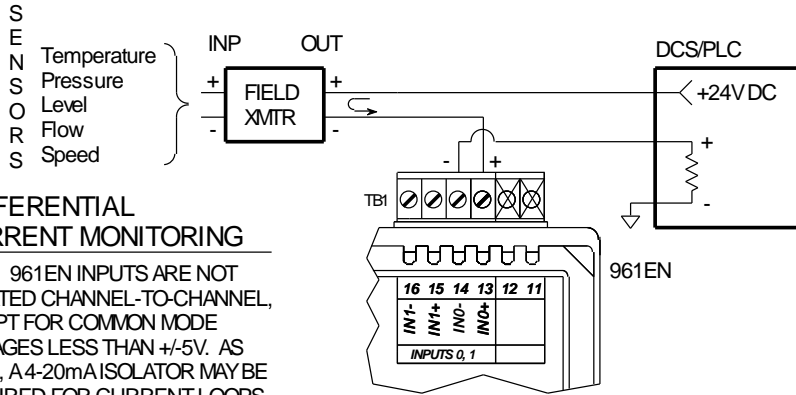

DIFFERENTIAL CURRENT MONITORING

NOTE: 961EN INPUTS ARE NOT ISOLATED CHANNEL-TO-CHANNEL, EXCEPT FOR COMMON MODE VOLTAGES LESS THAN +/-5V. AS SUCH, A 4-20mA ISOLATOR MAY BE REQUIRED FOR CURRENT LOOPS WITH LOADS GREATER THAN 250 OHMS.

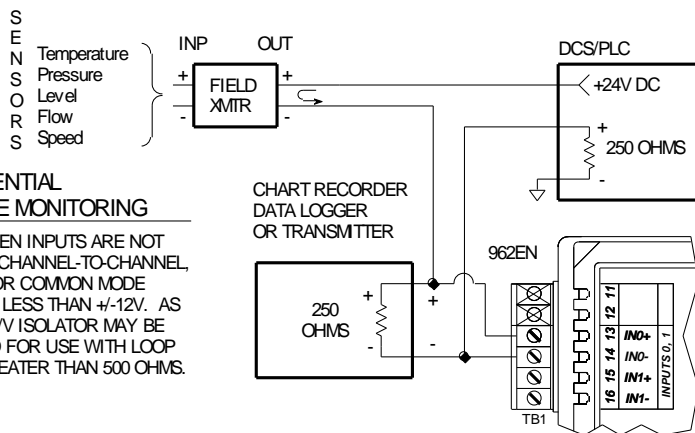

DIFFERENTIAL VOLTAGE MONITORING

NOTE: 962EN INPUTS ARE NOT ISOLATED CHANNEL-TO-CHANNEL, EXCEPT FOR COMMON MODE VOLTAGES LESS THAN +/-12V. AS SUCH, A V/V ISOLATOR MAY BE REQUIRED FOR USE WITH LOOP LOADS GREATER THAN 500 OHMS.

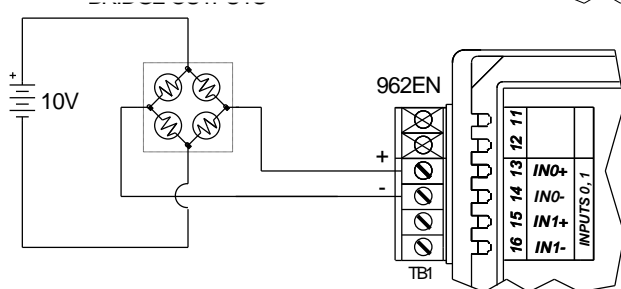

DIFFERENTIAL VOLTAGE MONITORING

NOTE: 962EN INPUTS ARE NOT ISOLATED CHANNEL-TO-CHANNEL, EXCEPT FOR COMMON MODE VOLTAGES LESS THAN +/-12V. AS SUCH, LIMIT BRIDGE EXCITATION TO 10V OR LESS.

- ✓ Connect Earth Ground as shown in the connection drawings above. Additionally, connect the GND terminal (TB3-33) to earth ground.

The ground connections noted are recommended for best results. If sensors are already grounded, use caution and avoid making additional ground connections which could create ground loops.

The plastic module housing does not require earth ground.

CONNECTIONS

Analog Inputs

Although the 961/962EN are not isolated channel-to-channel, they do provide common mode isolation for low level voltages in the range of ±12V (962EN), and ±5V (961EN). This makes these models useful for differential current and voltage monitoring applications similar to the examples shown here.

Earth Ground

Warning: To comply with safety and performance standards, use shielded cable and connect earth ground as noted. Failure to use good wiring and grounding practices may be unsafe and hurt performance.

WEB BROWSER

Home Page

This module supports Modbus over TCP/IP. You may use your own software to issue Modbus command to this module (see Modbus Registers), or you may use a standard web browser, as these modules have built-in web pages that allow you to setup, control, and calibrate the module. Simply execute your web browser, type the IP address assigned to your module in the "Address" window (<http://128.1.1.100/> for our example), click [Go], and you will be presented with a Home Page window similar to that shown below:

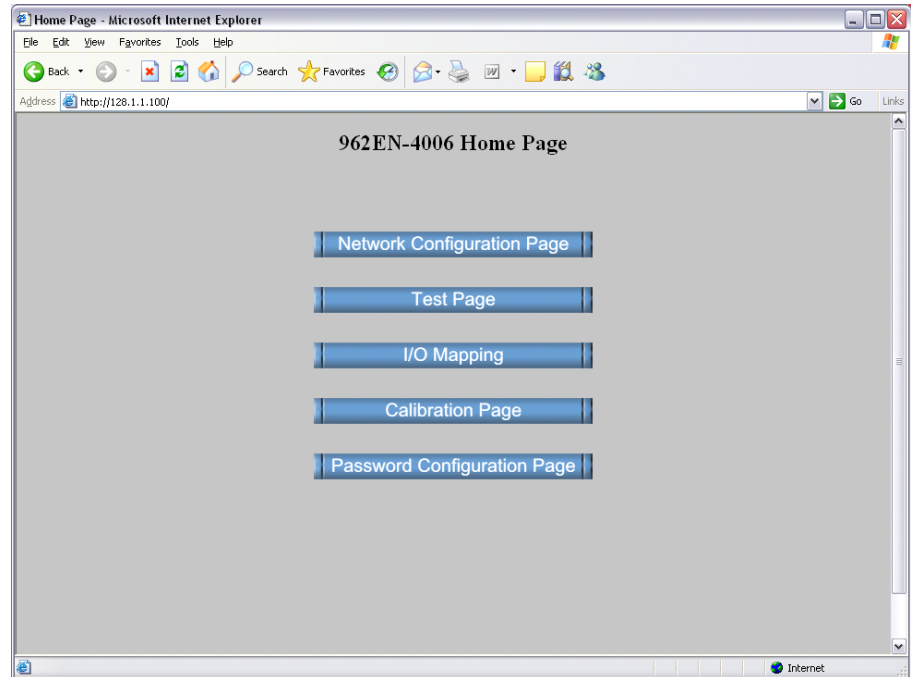

The Home Page provides buttons to access the other web pages of this module that are used to configure the network parameters, change the user name and password, map inputs to calibrate the module, and operate/test the module.

For each new browser session that accesses the Home Page of this module, you will be presented with a window prompting you to enter the current User Name and Password as shown below. This information is required before the program will allow you to make any other selections. **The default user name and password is "User" and "password00" respectively.** After entering these defaults, you may wish to invoke the Password Configuration Page to change these parameters to something more meaningful to you.



IMPORTANT: If you forget your installed user name & password, you can always toggle the module into default mode via the default mode toggle switch at the front of the module. Then the password and username will revert to the original defaults noted above, allowing you to re-invoke the Password Configuration Page and change the username and password settings as required.

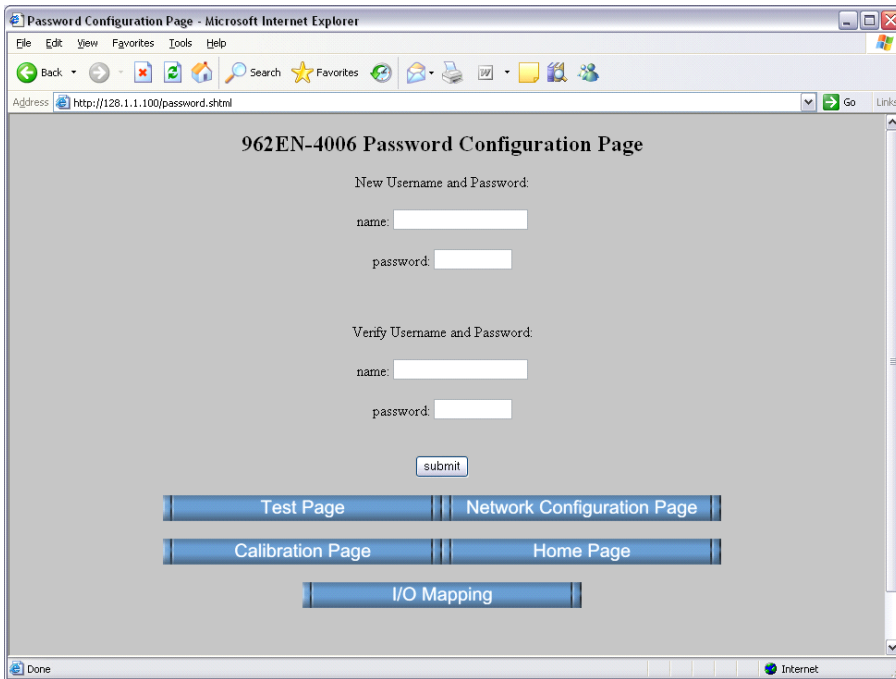

Password Configuration Page

Use up to 20 alphanumeric characters (case sensitive) to specify your username, and 10 alphanumeric characters (case sensitive) to specify a password. You will have to type in these entries twice to help prevent errors (yes, I know this is annoying).

Click the **submit** button to write your changes to the module.

After completing your username/password changes, click on the appropriate button at the bottom of the page to select another web page. If you made changes, you may be prompted to re-enter your new username and password before being permitted to move to other pages.

You can click the “Network Configuration Page” button to set the network configuration parameters for the module. You may have to consult your network administrator for help to complete the contents of this page.

Network Configuration

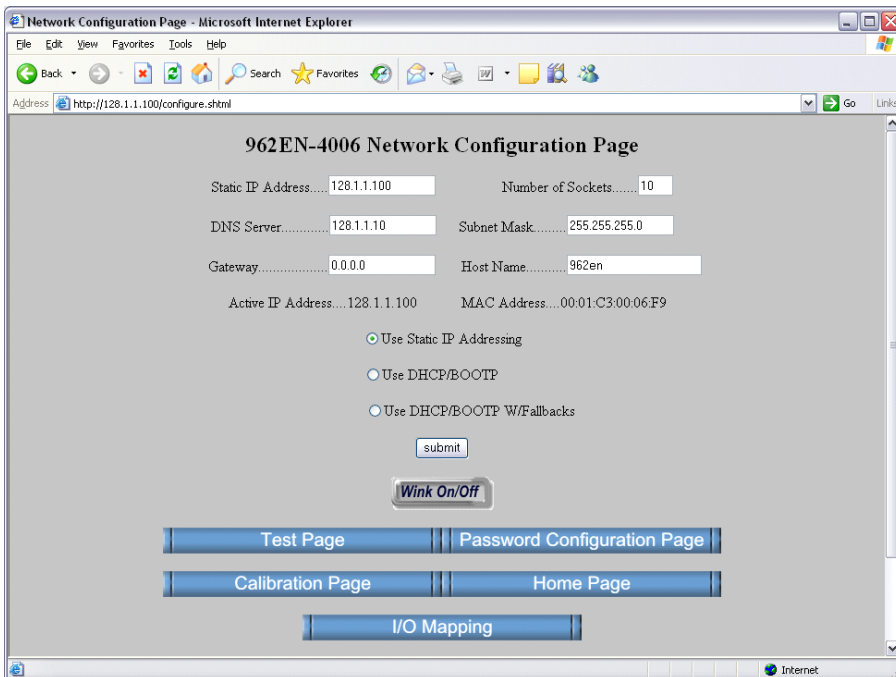

WEB BROWSER

Network Configuration

Note that Acromag Series 9xxEN Ethernet I/O modules may take from 3-30 seconds to boot upon power-up, depending on your network configuration and whether a DHCP server is present.

This module can be placed into a default communication mode via the DFT toggle switch at the front of the module.

Default Mode uses a static IP address of "128.1.1.100", a default subnet mask of "255.255.255.0", a default username "User", and a default password "password00".

An **IP Address** is a unique identification number for any host (this module) on any TCP/IP network (including the internet). The IP address is made up of four octets (8 bits), each octet having a value between 0-255 (00H-FFH). It is expressed here in decimal form, with a period placed between octets.

A **Static IP Address** is as the name implies—*static*, and represents a unique fixed IP Address that is generally assigned by your service provider or system administrator. The default static IP address assigned to this module from the factory is 128.1.1.100 (refer to product side label).

NOTE: In order to network your PC with an Acromag module, you may have to consult with your network administrator and either temporarily change your TCP/IP configuration (see TCP/IP Properties of Network Configuration in Windows), or create a separate private network using a second network adapter installed in your PC (recommended). The necessary steps will vary with your operating system. Refer to Acromag Application Note 8500-734 to help accomplish this (located on the CDROM shipped with your module or via download from our web site at www.acromag.com).

The **Number of Sockets** refers to the number (1-10) of Modbus TCP/IP access points to allow for this host. The default allows up to 10 sockets, but you can restrict access by reducing this number. Internally, the module uses port number 502 which is reserved for Modbus.

The **DNS Server** refers to the IP address of the Domain Name Server used on this network. A DNS server relates symbolic names to actual IP addresses, while the DHCP server is responsible for dynamically passing out IP addresses.

A **Subnet Mask** is used to subdivide the host portion of the IP address into two or more subnets. The subnet mask will flag the bits of the IP address that belong to the network address, and the remaining bits correspond to the host portion of the address. The unique subnet to which an IP address refers to is recovered by performing a bitwise AND operation between the IP address and the mask itself, with the result being the sub-network address.

Gateway refers to the IP Address of the gateway, if your local area network happens to be isolated by a gateway. Typically, it is assigned the first host address in the subnet. If a gateway is not present, then this field should contain an unused address within the host subnet address range.

The **Host Name** is the name to be assigned to this host if its address happens to be assigned dynamically using DHCP.

The **Active IP Address** refers to the current IP Address being used by this host, as opposed to any new assignments being made via this page.

The **MAC Address** refers to the Media Access Control Address that uniquely identifies the hardware of this device. This is a unique fixed address assigned to this module at the factory. On IEEE 802 networks, the Data Link Control (DLC) layer of the OSI Reference Model is divided into two sublayers: the Logical Link Control (LLC) layer, and the Media Access Control (MAC) layer. The MAC layer interfaces directly with the network media (each different type of network media requires a different MAC layer).

By default, the module is setup to use **Static IP Addressing and a Static IP Address of 128.1.1.100**. You can optionally choose to have the IP address assigned dynamically via DHCP/BOOTP or DHCP/BOOTP w/Fallback. This will also require that you specify a valid Host Name. Note that DHCP/BOOTP w/Fallback will revert to the static IP address if your DHCP or BOOTP server cannot be found at the address specified.

In general, BOOTP (Bootstrap Protocol) refers to an internet protocol that enables a diskless workstation to discover its own IP address, the address of a BOOTP server on the network, and a file to be loaded into memory to boot the machine. This enables the workstation or device server to boot without requiring a hard or floppy disk drive. BOOTP works similar to DHCP, but is usually found in older systems. This protocol is defined by RFC 951.

DHCP (Dynamic Host Configuration Protocol) refers to a protocol for assigning dynamic IP addresses to devices on a network. With dynamic addressing, a device can have a different IP address every time it connects to the network. In some systems, it can even change while it is still connected. DHCP also supports a combination of static and dynamic IP addresses. DHCP/BOOTP with fallback will revert to static IP addressing if the DHCP or BOOTP server cannot be found.

The unit includes a default address toggle switch to cause the module to assume a preset default factory address. This switch is at the front of the module and is used to toggle the module into, or out of Default Mode. If you use the toggle switch at the front of the module to place the module in default mode, then "Default Communications Mode" will be indicated at the bottom of this screen.

Click the **Submit** button to complete any changes made on this page.

Click the **Wink On/Off** button to toggle the module in/out of "wink" ID mode. In this mode, the module's green RUN LED will blink to confirm identification as an aide to locating a specific module on a network.

Refer to the Technical Reference section of this manual to learn more about IP Addressing terms and concepts.

WEB BROWSER

Network Configuration

The Default Communication Mode uses a static IP address of "128.1.1.100", a default subnet mask of "255.255.255.0", a default username of "User", and a default password of "password00".

WEB BROWSER

I/O Mapping Page (Optional i2o Function)



This messaging function works best if the target module(s) are already online and ready to receive messages. It will still work if the target output modules come online after the input module, but may take several minutes to “discover” all the network targets and begin transmitting to them.

If the input module or the target module(s) go offline, remote messaging will resume on its own when the connection is re-established, but this “healing” function may take several minutes depending on which device(s) went offline, why, and for how long.

Note: Remote messaging may only be configured via the built-in web browser page as there are no Modbus registers for specifying these parameters.

The actual data written to the analog output is in percent-of-span units represented by a 16-bit signed integer value with resolution of 0.005%/lsb. For example, -100%, 0% & +100% will be represented by the decimal values -20000, 0, and 20000, respectively. Input data may not be rescaled.

This module includes special messaging functionality (i2o, input-to-output communication) that allows it to send its input level to an output channel on an Acromag 972EN-400x or 973EN-400x analog output module. The I/O Mapping page is used to specify the static IP address of the 972/973EN module to send an input channel's data to, the specific Holding Register address of that module, and an update rate.

IMPORTANT: This module is designed to function as a Modbus TCP/IP slave/server. Normally, Modbus servers are not allowed to initiate messages on their own and may only respond to client/master requests. The I/O mapping function is a special application that may cause confusion for master/client devices linked to the same network. Other master devices should be restricted from attempting to control i2o target devices.

Each input channel of this device may be mapped to one or two output channels of Acromag 972EN-400x (current output), or 973EN-400x (voltage output) modules. The output channel that is to be controlled in this manner is determined by the Map-To Holding Register address specified. The data written will be in identical percent-of-span units with no rescaling. Subsequent messages will be sent at a periodic rate specified via the update time. Note that the target output channels may still be controlled independently, but their level will be overwritten by subsequent mapped messages when enabled.

Channel Number	Update Time(Sec)	Map To IP Address	Map To Holding Register	Mapping Method
0	0	0.0.0.0 0.0.0.0	40019 40019	<input checked="" type="radio"/> Unipolar <input type="radio"/> Bipolar
1	0	0.0.0.0 0.0.0.0	40020 40020	<input checked="" type="radio"/> Unipolar <input type="radio"/> Bipolar
2	0	0.0.0.0 0.0.0.0	40021 40021	<input checked="" type="radio"/> Unipolar <input type="radio"/> Bipolar
3	0	0.0.0.0 0.0.0.0	40022 40022	<input checked="" type="radio"/> Unipolar <input type="radio"/> Bipolar
4	0	0.0.0.0 0.0.0.0	40023 40023	<input checked="" type="radio"/> Unipolar <input type="radio"/> Bipolar
5	0	0.0.0.0 0.0.0.0	40024 40024	<input checked="" type="radio"/> Unipolar <input type="radio"/> Bipolar

Use the scroll bar on the right to scroll down to the bottom of this screen as shown on the following page.

The I/O Mapping Page of model 962EN-4006 is slightly different than the 961EN-4006 as it requires that the mapping method be selected. That is, the 962EN input signal range is bipolar and you must additionally select whether the mapping is to be bipolar (0V input maps to 50% output), or unipolar (0V input maps to 0% output). You can map each input channel to one or two analog output channels of another 972EN or 973EN module.

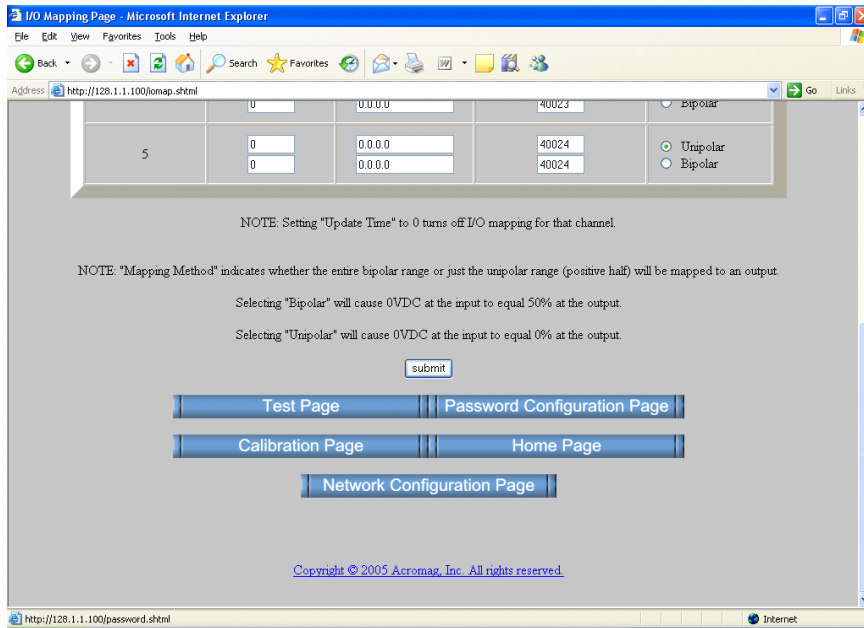

WEB BROWSER

**I/O Mapping Page
(Optional i2o Function)**

Update Time: Specify a time from 0-90 seconds between messages. Specify 0 to turn mapped messaging OFF.

Map To IP Address: This is the Static IP Address of the target output device (a 972/973EN module on the network).

Map To Holding Register Address: Specify a valid 4xxxx holding register address in the target device for writing to the output. For the 972/973EN, only addresses 40019 to 40024 will apply and correspond to channels 0-5.

Mapping Method (962EN): Since the input signal is bipolar and the output channel is unipolar, you may select “Unipolar” to map 0V input to 0% output, or “Bipolar” to map 0V input to 50% output.

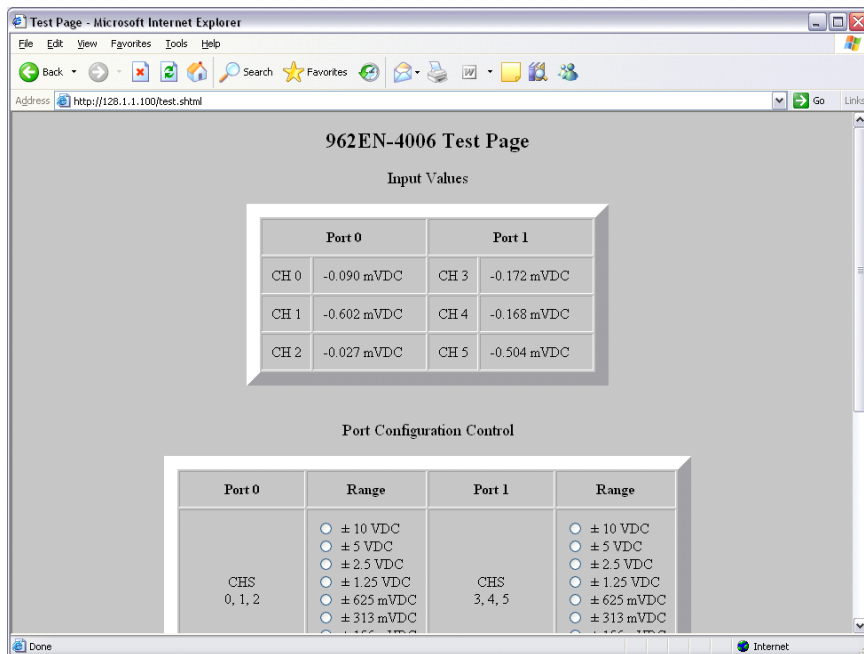

Test Page

After the username and password assignment, plus setting your network configuration parameters, you can use the Test Page shown at left to operate your module. The Test Page will allow you to read inputs and change input ranges on this model.

WEB BROWSER

Test Page

TIP: Viewing a module's web page is treated similar to viewing a web page on the internet. The first time you open a page, its image is stored as a temporary internet file in PC memory. However, each subsequent attempt to view that page will need to automatically update that image, especially when making configuration changes. With Internet Explorer, click the "Internet Options" of the "Tools" menu, select the "General" tab, locate the "Temporary Internet Files" information and click on the "Settings" button. Then select "Automatically" under "Check for newer versions of stored pages:". Then click [OK] to return to the "General" screen, and click [OK] again to save your settings.

Use the scroll bar on the right to scroll down the page as shown below:

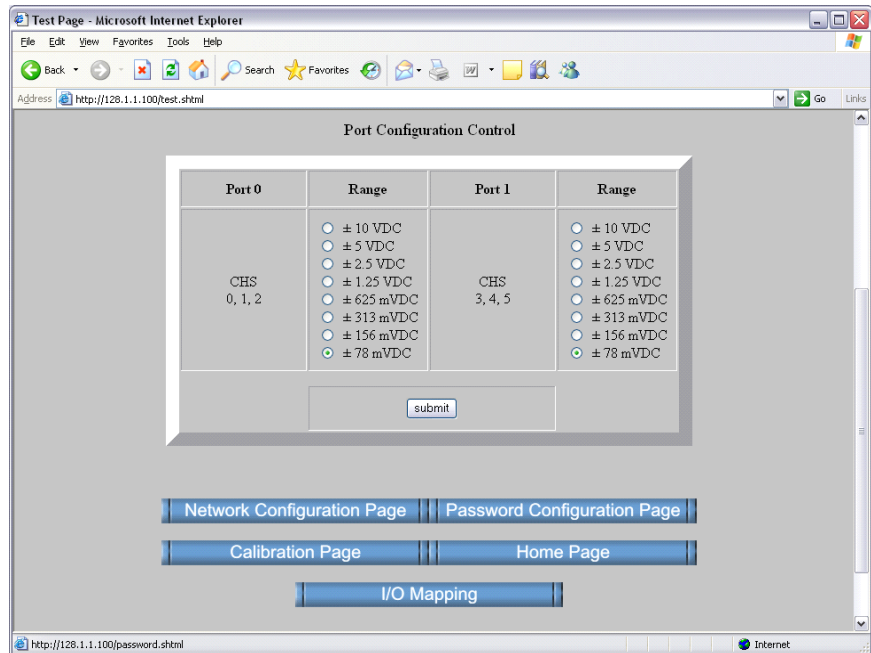

Note that the 6 channels of these modules are divided into 2 groups of 3 channels each. Note that the channels of each group (0, 1, & 2, and 3, 4, & 5) share the same input configuration, but the configuration may vary between the two groups.

IMPORTANT: The input signal indicated only reflects the level of the inputs at the moment this screen is invoked and this does not continuously update. You can click your browser's refresh button to get a new input update.

You can also use the Configuration Control of this page to change the input range for each channel group (0, 1, & 2 or 3, 4, & 5). For the 961EN shown, you may select from 0-20mA, 4-20mA, 0-11.17mA, and 0-1mA DC current ranges. For the 962EN, you may select $\pm 10V$, $\pm 5V$, $\pm 2.5V$, $\pm 1.25V$, $\pm 625mV$, $\pm 313mV$, $\pm 156mV$, or $\pm 78mV$ DC voltage ranges. Note that your range selection will apply to all channels of the group. Click on "submit" to execute your range change.

The Calibration Page will allow you to recalibrate each channel's zero and span signal as required. Simply select the channel to be calibrated, choose zero or span, apply the zero or full-scale signal to the input, then click calibrate. For best results, always calibrate zero before span.

Calibration Page

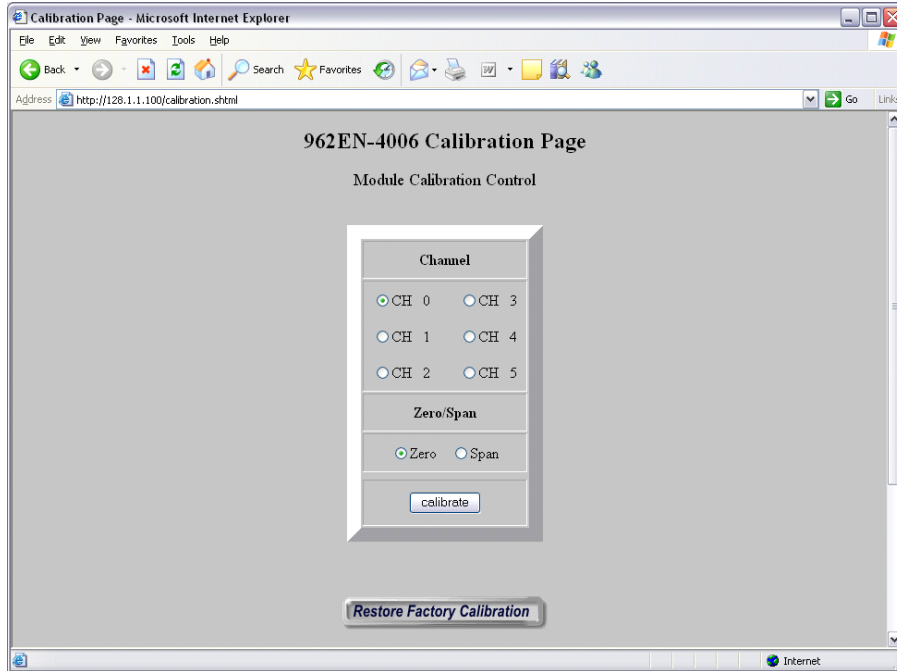

IMPORTANT: This module has already been calibrated at the factory and recalibration is not normally required, except as necessary to correct for long term component aging, or to satisfy your company's maintenance requirements. Do not attempt to recalibrate this module unless absolutely required, as miscalibration will negatively affect the module's performance.

You can choose to use the web browser calibration page above to accomplish calibration (Method 1, easiest), or via direct register access as described in Method 2 of the following page.

Your success in recalibrating the input will strongly depend upon the accuracy and precision of your signal source.

If recalibration of any input is required, all applicable ranges should be done. The following table gives the calibration values for the input ranges of these models. These are the input signals required to calibrate the range endpoints. Note that on the 961EN-4006, the 4-20mA range is a sub-range of the 0-20mA range and is automatically calibrated at the same time.

WEB BROWSER

Input Calibration

Model 961EN-4006 Range	ZERO Calibration	FS Calibration
0-20mA DC, 4-20mA DC	1.0mA	20.0mA
0-11.17mA DC	1.0mA	11.17mA
0-1mA DC	0.25mA	1.00mA
Model 962EN-4006 Range	ZERO Calibration	FS Calibration
±10V DC	-10000.0mV	10000.0mV
±5V DC	-5000.0mV	5000.0mV
±2.5V DC	-2500.0mV	2500.0mV
±1.25V DC	-1250.0mV	1250.0mV
±625mV DC	-625.0mV	625.0mV
±313mV DC	-312.50mV	312.50mV
±156mV DC	-156.25mV	156.25mV
±78mV DC	-78.13mV	78.13mV

Note (961EN): The 4-20mA range is calibrated with the 0-20mA range and is not calibrated separately. All other ranges are calibrated separately.

IMPORTANT: For best results, be sure to use a precision signal source capable of reproducing the nominal endpoint signals at least as accurate as the module itself (better than $\pm 0.1\%$ of span). Always allow the module to warm up a few minutes prior to calibration.

You can choose to use the web browser calibration page to accomplish calibration (easiest), or via direct register access as described below.

Method 1 – Calibration Using The Built-In Browser Interface:

1. Make sure that the range that needs calibrating is currently selected.
2. Bring up browser interface and select calibration page.
3. Apply either the zero or span input signal to the channel to be calibrated. Calibrate the zero endpoint signal first, before the span endpoint signal.
4. Wait about 10 seconds for the input to settle and be read.
5. Click on the channel number and select either zero or span calibration.
6. Click on the “Calibrate” button. The page will refresh and calibration may continue. Repeat this process for the other endpoint (span).
7. Repeat steps 2-5 for the other input channels to be calibrated.

Method 2 - Calibration Via The Modbus TCP/IP Interface:

1. Write to the appropriate Port Input Range Register to select the input range to be calibrated for your channel of interest.
2. Write 24106 (5E2AH) into the Calibration Access Register to remove write protection from the calibration registers.
3. Apply the zero calibration signal (Cal Lo, see table) to the input to be calibrated and allow the input to settle about 10 seconds.
4. Write a 16-bit value to the Zero Calibration Register with a set bit in the bit position that corresponds to the channel number to be calibrated (one channel at a time). If you were calibrating the zero of channel 5, you would write 0x0020 to the Zero Calibration Register. The module will replace calibration coefficients immediately, no reset needed.
5. Apply the full-scale calibration signal (Cal Hi, see table) to the input to be calibrated and allow the input to settle about 10 seconds.
6. Write a 16-bit value to the Span Calibration Register with a set bit in the bit position that corresponds to the channel number of the channel to be calibrated (one channel at a time). For example, if you wanted to calibrate the span of channel 0, write 0x0001 to the “Span Cal Register”.
7. Write to the Port Input Range Register to select the next range to be calibrated at this channel. Repeat steps 3-6 for this range as required.
8. Repeat steps 3-7 for the other channels as required.
9. When finished calibrating, write 0x0000 to the Calibration Access Register (Holding register 21) to replace write protection to the calibration registers and prevent miscalibration.

Upon power-up, the green "Run" LED should light. A continuous blinking Run LED indicates "wink" ID mode. If the Run LED remains OFF and correct power has been applied, then either the internal power supply has failed or a fatal processor error (firmware) has occurred.

TROUBLE-SHOOTING

Diagnostics Table

SYMPTOM	POSSIBLE CAUSE	POSSIBLE FIX
<i>Green RUN LED does not light.</i>	Internal +3.3V power has failed.	Return module for repair.
<i>Continuous flashing green RUN LED.</i>	Module in "wink" mode.	Read Module Status register to verify "wink" status. Write 5555H to Wink Mode Toggle Register to toggle wink mode off/on.
<i>Cannot communicate.</i>	Power ON at the module?	Check power. Is green RUN LED ON?
	Connecting cable is not a crossover cable. <i>TIP: To check cable type, hold both ends in same position and read the wire colors through the clear portion of the plug from left to right. If colors are arranged in the same order, you have a straight cable.</i>	This module's ethernet port is wired MDI. You must use a crossover cable when connecting this module to your PC or another device also wired MDI. If you are connecting to an Ethernet switch or hub, then a direct cable is used. Note: If your Link LED is ON, you have connected using the correct type of cable, but it could still be defective.
	Wrong IP Address	Change the IP address of the module or the PC so that both match. Try the default module address of 128.1.1.100. For the PC NIC, try another address.
<i>Many Communication Errors.</i>	Is cable segment longer than 100M?	Maximum distance between two nodes is limited to 100 meters using approved cable.
	Correct Cable?	Shielded CAT-5/5E cable or equivalent is recommended.
	Missing earth ground connection.	Connect earth ground to TB3-33 GND terminal adjacent to power terminal.
<i>Cannot Browse Module.</i>	Your browser may be setup to use a proxy server for LAN communications.	Temporarily disable the use of a proxy server by your browser (see procedure of next page).

If your problem still exists after checking your wiring and reviewing this information, or if other evidence points to another problem with the unit, an effective and convenient fault diagnosis method is to exchange the module with a known good unit. Acromag's Application Engineers can provide further technical assistance if required. Complete repair services are also available from Acromag.

TROUBLE-SHOOTING

Please refer Acromag Application Note 8500-734 for help in setting up network communication with your module (located on the CDROM shipped with your module or via download from our web site at www.acromag.com). This document gives details for changing your PC's TCP/IP configuration in order to communicate with your module (see TCP/IP Properties of Network Configuration in Windows). For additional information, you may also wish to download whitepaper 8500-765, Introduction To Modbus TCP/IP.

Trouble Browsing Your Module?

If you have carefully followed this procedure and you still cannot browse your module, you may have the web browser of your laptop or PC setup to use a proxy server when browsing the web. If you are using Internet Explorer, Refer to the "Tools" pulldown menu, select "Internet options...", click the "Connections" tab, then click the "LAN Settings" button. Locate the Proxy server information and uncheck the box next to the statement "Use a proxy server for your LAN". Then click [OK] to return to the "Connections" screen, and click [OK] again to save your settings.

You should now be able to use Internet Explorer to browse the module as required. However, to later restore your PC's connection to your company network, you may have to re-enable the use of a proxy server for your LAN.

Getting Out Of Trouble

There is no built-in error detection to prevent you from writing invalid values to a configuration register. As such, if you inadvertently write an invalid value to an internal register, you could cause the module to become inoperable under certain conditions. If this happens, in order to regain control of the module, the module can either be re-downloaded at the factory, or you can try restoring the module to its initial configuration by following this procedure:

So, your module's "gone wild", follow this procedure to restore it to its initial configuration and regain control.

Procedure For Restoring any 9xxEN Module to its Initial Configuration

1. While module power is OFF, press and hold the front-panel toggle switch in the default (DFT left) position.
2. While continuing to hold the toggle switch in the default position, apply power to the module.
3. After a few seconds, the Status LED will begin to blink quickly and you can release the default switch at this point. The module will continue to boot itself as it normally does. That is, the green RUN LED will blink for 1-10 seconds as the unit acquires its address, then remain ON for normal operation.
4. If the STATUS LED fails to blink rapidly after a few seconds and the RUN LED just blinks for a few moments as it normally does, then reinitializing the module has failed and you should try it again. This time, make sure that the DFT switch is completely depressed and held while powering the unit. Also make sure that you are pressing the DFT toggle in the DFT direction (left), rather than the RST direction (right).

Note that if you perform the procedure for restoring a module to its original configuration as outlined above, all of the I/O mapping variables are returned to their default values and mapping may have to be reconfigured.

TECHNICAL REFERENCE

- **Safety Agency Approvals** – CE, UL, & cUL listed, plus Class I; Division 2; Groups A, B, C, D approval.
- **Fully Isolated** – Input channels (as a group), network, and power are all isolated from each other for safety and increased noise immunity.
- **Modbus TCP/IP Protocol Support** – Supports up to 10 master sockets (the maximum number of sockets is user-selectable) using the Modbus TCP default port number 502.
- **I/O Mapping (i2o) Feature** – I/O Mapping feature allows the inputs of this device to control the outputs of an Acromag 972EN-400x or 973EN-400x analog output module.
- **Built-In Web Pages** - Allows unit to optionally be configured, controlled, calibrated, and monitored with a standard web browser over ethernet.
- **Convenient “Wink” ID Mode Support** – Blinks green RUN LED in wink mode as a visual tool to help identify specific remote units on a network.
- **Fully Independent w/ Direct I/O Connection** – Self-contained with no special bus couplers, power supply, or rack mount required to operate.
- **Isolated Network Interface** – Immune to noise & can operate over long distances. Allows many modules to network together.
- **Network Port is Transient Protected** – Shielded RJ45 port includes transient protection from ESD, EFT, and other transients.
- **10Base-T and 100Base-TX Support** – Integrated IEEE 802.3/802.3u 100Base-TX/10Base-T.
- **Auto-Negotiated 10/100Mbps, Half or Full Duplex.**
- **Flexible Multi-Range Analog Inputs** - Accepts either DC current or DC voltage, according to model number.
- **Range Variability** – The first 3 channels must share the same range, but this can be different than the range of the last 3 channels.
- **Optional AC Current Input (961EN Only)** - An optional AC current sensor can be purchased separately to support AC current inputs.
- **Precise High-Resolution A/D Conversion** – Modules use high-resolution, low noise, sigma-delta analog-to-digital conversion for high accuracy and reliability.
- **Plug-In Terminal Blocks & DIN-Rail Mount** - Make mounting, removal, and replacement easy.
- **Nonvolatile Reprogrammable Memory** – Allows the functionality of this device to be reliably reprogrammed thousands of times.
- **Operation/Diagnostic LED Indicators Aide Troubleshooting** – Yellow ACT LED indicates port activity (busy). Green LNK LED indicates link (auto-negotiation complete & connection established). Green RUN LED indicates power/wink ID mode. Yellow ST LED indicates module status.
- **Self-Diagnostics & Built In Watchdog** - For easy maintenance and troubleshooting. Includes a hardware watchdog timer built into the microcontroller that causes it to initiate a self reset if the controller ever “locks up” or fails to return from an operation in a timely manner.
- **Wide-Range DC-Power** – Wide range diode-coupled for use with redundant supplies, and/or battery back-up.
- **Hardened For Harsh Environments** - For protection from RFI, EMI, ESD, EFT, & surges. Has low radiated emissions per CE requirements.
- **Wide Ambient Operation** – Reliable over a wide temperature range.

KEY FEATURES

HOW IT WORKS

These input modules provide up to six process current (961EN), or six differential DC voltage (962EN) input channels, and provide an isolated 10/100 Ethernet interface for configuration, monitoring, and control of the input module. The current input model (961EN) uses precision 24.9Ω current sink resistors across the inputs. Voltage input models use 10:1 precision resistor voltage dividers at the input. A multiplexer is used to connect each input voltage to an A/D converter (separate A/D channels serve 3 input channels each). The A/D converter then applies appropriate gain to the signals, performs analog-to-digital conversion, and digitally filters the signals. The microcontroller completes the transfer function according to the input type and its embedded program. Configuration and calibration parameters are stored in non-volatile memory integrated within the microcontroller. A dedicated Ethernet controller handles Ethernet communication. The I/O terminals and the Ethernet port terminals also include transient suppression. A wide input switching regulator (isolated flyback) provides isolated power to the I/O circuits and the Ethernet controller. Refer to the simplified schematic shown below to help gain a better understanding of the circuit.

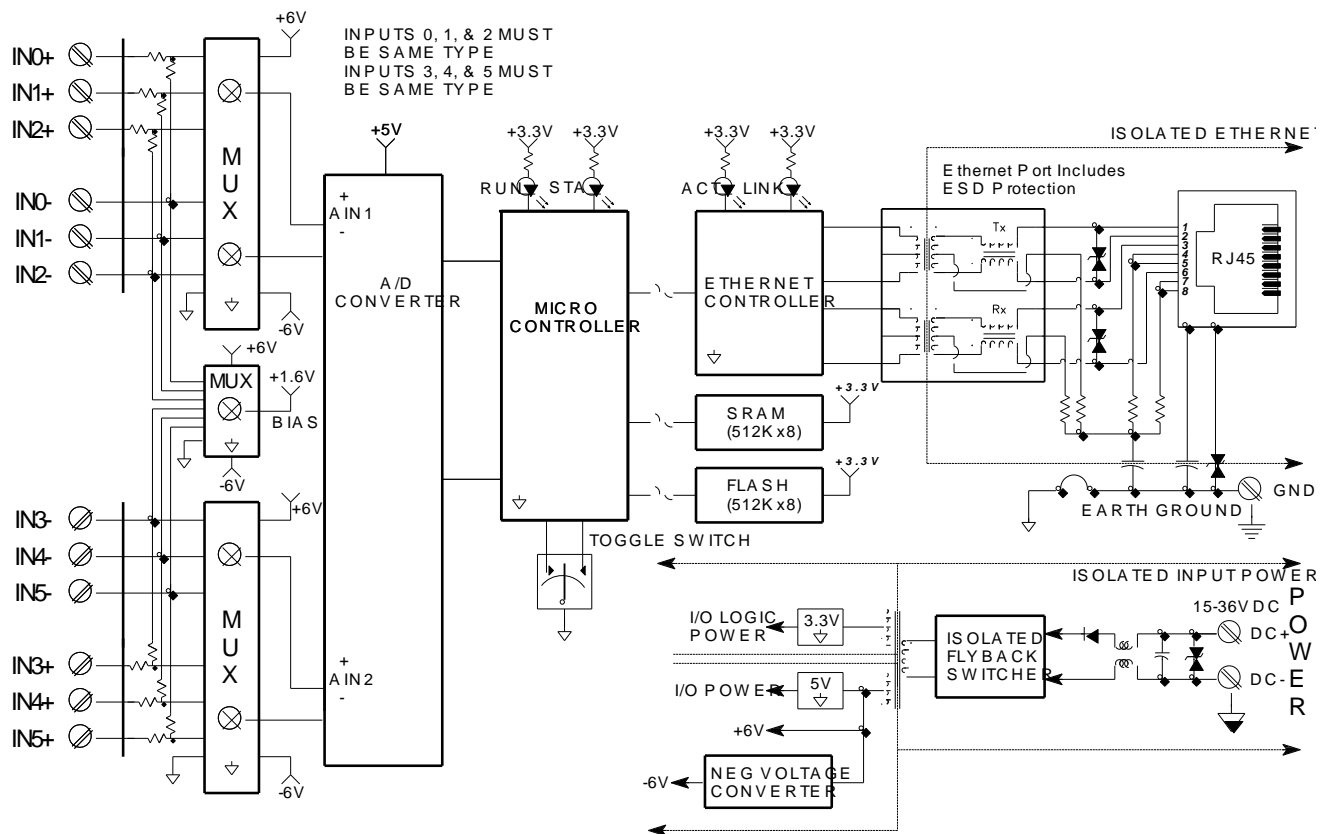

Note that input types may vary between the two channel groups—channel 0, 1, and 2 may be configured differently from channel 3, 4, and 5. Inputs are not isolated channel-to-channel, except for small common mode voltage differences in the range of $\pm 5V$ (961EN), or $\pm 12V$ (962EN).

TCP/IP is the foundation for the World Wide Web and refers to Transmission Control Protocol and Internet Protocol. TCP/IP allows blocks of binary data to be exchanged between computers. The primary function of TCP is to ensure that all packets of data are received correctly. IP makes sure that messages are correctly addressed and routed. Note that the TCP/IP combination does not define what the data means or how the data is to be interpreted, it is merely a *transport protocol*.

Modbus is an *application protocol*. It defines rules for organizing and interpreting data and is essentially a messaging structure that is independent of the underlying physical layer. It is freely available and accessible to anyone, easy to understand, and widely supported by many manufacturers.

Modbus TCP/IP uses TCP/IP and Ethernet to carry the data of the Modbus message structure between devices. That is, Modbus TCP/IP combines a physical network (Ethernet), with a networking standard (TCP/IP), and a standard method of representing data (Modbus). A Modbus TCP/IP message is simply a Modbus communication encapsulated in an Ethernet TCP/IP wrapper.

In practice, Modbus TCP embeds a Modbus data frame into a TCP frame, without the Modbus checksum, as shown in the following diagram. The Modbus checksum is not used, as the standard ethernet TCP/IP link layer checksum methods are instead used to guaranty data integrity.

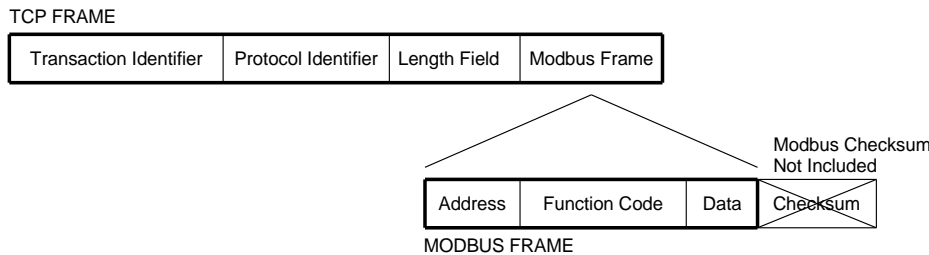

Note that the Modbus address field is referred to as the *Unit Identifier* in Modbus TCP. In a typical slave application, the Unit ID is ignored and just echoed back in the response.

The operation of the 961/962EN industrial Ethernet modules is very similar to Acromag's 913/914MB ModBus modules. The operation over Ethernet is essentially transparent to the Modbus register/command structure. If you are already familiar with Modbus or with Acromag Series 900MB modules, then you are already familiar with the operation of the 961/962EN modules.

A host is any device on any network. On TCP/IP networks, each host has one or more unique IP addresses. This module connected to an ethernet network is a host.

An IP Address is a unique identification number for any host (this module) on any TCP/IP network (including the internet). The IP address is made up of four octets (8 bits), each octet having a value between 0-255 (00H-FFH). The IP address is comprised of two parts: the network address (first part) and the host address (last part). The number of octets of the four total that belong to the network address depend on the Class definition (see below).

ABOUT MODBUS TCP/IP

You can find more information on Modbus TCP/IP by visiting our web site and down-loading whitepaper 8500-765, *Introduction To Modbus TCP/IP*.

IP Addressing

IP Addressing

A *Static IP Address* is as the name implies—static. That is, it is a unique IP Address that is assigned by a service provider and never changes.

A *Dynamic IP Address* is an address that is temporarily assigned to a user by a service provider each time a user connects.

A *Subnet* is a contiguous string of IP addresses. The first IP address in a subnet is used to identify the subnet and usually addresses the server for the subnet. The last IP address in a subnet is always used as a broadcast address and anything sent to the last IP address of a subnet is sent to every host on that subnet.

Subnets are further broken down into three size classes based on the 4 octets that make up the IP address. A Class A subnet is any subnet that shares the first octet of the IP address. The remaining 3 octets of a Class A subnet will define up to 16,777,214 possible IP addresses ($2^{24} - 2$). A Class B subnet shares the first two octets of an IP address (providing $2^{16} - 2$, or 65534 possible IP addresses). Class C subnets share the first 3 octets of an IP address, giving 254 possible IP addresses. Recall that the first and last IP addresses are always used as a network number and broadcast address respectively, and this is why we subtract 2 from the total possible unique addresses that are defined via the remaining octet(s).

For our example, the default IP address of this module is 128.1.1.100. If we assume that this is a Class C network address (based on the default Class C subnet mask of 255.255.255.0), then the first three numbers represent this Class C network at address 128.1.1.0, the last number identifies a unique host/node on this network (node 100) at address 128.1.1.100.

A *Subnet Mask* is used to determine which subnet an IP address belongs to. The use of a subnet mask allows the network administrator to further divide the host part of this address into two or more subnets. The subnet mask flags the network address portion of the IP address, plus the bits of the host part that are used for identifying the sub-network. By convention, the bits of the mask that correspond to the sub-network address are all set to 1's (it would also work if the bits were set exactly as in the network address). It's called a mask because it can be used to identify the unique subnet to which an IP address belongs to by performing a bitwise AND operation between the mask itself, and the IP address, with the result being the sub-network address, and the remaining bits the host or node address.

Note that the first node address (0) and node 10 are typically reserved for servers and should not be used. The last node (255) is a broadcast address. Node 100 is the default address of this module. Use of these node addresses for any other purpose may yield poor performance.

For our Example, if we wish to further divide this network into 14 subnets, then the first 4 bits of the host address will be required to identify the subnetwork (0110), then we would use "11111111.11111111.11111111.11110000" as our subnet mask. This would effectively subdivide our Class C network into 14 subnetworks of up to 14 possible nodes each.

With respect to the default settings of this module:

Subnet Mask 255.255.255.0 (11111111.11111111.11111111.00000000)
 IP Address: 128.1.1.100 (10000000.00000001.00000001.01100100)
 Subnet Address: 128.1.1.0 (1000000.00000001.00000001.00000000)

Subnetwork address 128.1.1.0 has 254 possible unique node addresses. We are using node 100 of 254 possible for our module.

DHCP refers to Dynamic Host Configuration Protocol and is a method used to dynamically assign temporary numeric IP addresses as required. A DHCP server maintains a pool of shared IP addresses which are recycled. When a DHCP device wants to use a TCP/IP application, it must request an IP address from the DHCP server. The DHCP server will check the shared supply, and if all addresses are in use, the server will send a busy signal to the client which tells it to try again later. Static addresses will ensure a connection every time, but dynamic addresses do not.

Dynamic Host Configuration Protocol (DHCP)

DNS refers to the Domain Name System or Domain Name Server and refers to the system used to associate an alphanumeric character string with a numeric IP address. The DNS is actually a distributed database of domain names and corresponding IP addresses. The DNS allows us to use Acromag.com as an IP address rather than a complicated string of numbers. Note that name servers contain information on some segment of the domain name space and make this information available to clients called *resolvers*.

Domain Name System (DNS)

Modbus registers are organized into reference types identified by the leading number of the reference address:

MODBUS REGISTERS

Reference	Description
0xxxx	<u>Read/Write Discrete Outputs or Coils.</u> A 0x reference address is used to drive output data to a digital output channel.
1xxxx	<u>Read Discrete Inputs.</u> The ON/OFF status of a 1x reference address is controlled by the corresponding digital input channel.
3xxxx	<u>Read Input Registers.</u> A 3x reference register contains a 16-bit number received from an external source—e.g. an analog signal.
4xxxx	<u>Read/Write Output or Holding Registers.</u> A 4x register is used to store 16-bits of numerical data (binary or decimal), or to send the data from the CPU to an output channel.

The “x” following the leading character represents a four-digit address location in user data memory.

The leading character is generally implied by the function code and omitted from the address specifier for a given function. The leading character also identifies the I/O data type.

Note: The ON/OFF state of discrete inputs and outputs is represented by a 1 or 0 value assigned to an individual bit in a 16-bit data word. This is sixteen 0x or 1x references per data word. With respect to mapping, the LSB of the word maps to the lowest numbered channel of a group and channel numbers increase sequentially as you move towards the MSB. Unused bit positions are set to zero.

All I/O values are accessed via the 16-bit Input or Holding Registers given in the Register Map. Input registers contain read-only information. For example, the current input value read from a channel, or the states of a group of digital inputs. Holding registers contain read/write information that may be configuration data or output data. For example, the high limit value of an alarm operating at an input, or an output value for an output channel.

Register Functions

Each module has a default factory configuration as noted in the SPECIFICATIONS section. Your application will likely differ from the default configuration and the module will need to be reconfigured. You may reconfigure this module by issuing the appropriate Modbus functions to Register Map registers, as required by your application. You may also use a standard web browser to access the built-in web pages of the module to perform basic operations.

Register Functions

IMPORTANT: When using your own software to manipulate the module, please note that the maximum query through the Modbus TCP interface is only 50 registers, due to the maximum buffer size limitations of the TCP/IP stack. As such, you can only request data from 50 registers at one time for commands that access multiple registers. For example, the Read Holding Registers command may only retrieve the contents of registers 40001 to 40051 in one read.

Below is a subset of standard Modbus functions that are supported by this module along with the reference register addresses that the function operates on. Use these functions to access these registers as outlined in the Register Map for sending and retrieving data.

The following Modbus functions operate on register map registers to monitor, configure, and control module I/O:

CODE	FUNCTION	REFERENCE
01 (01H)	Read Coil (Output) Status	0xxxx
02 (02H)	Read Input Status	1xxxx
03 (03H)	Read Holding Registers	4xxxx
04 (04H)	Read Input Registers	3xxxx
05 (05H)	Force Single Coil (Output)	0xxxx
06 (06H)	Preset Single Register	4xxxx
15 (0FH)	Force Multiple Coils (Outputs)	0xxxx
16 (10H)	Preset Multiple Registers	4xxxx
17 (11H)	Report Slave ID (See Below)	Hidden

If an unsupported function code is sent to a module, exception code 01 (Illegal Function) will be returned in the response. If a holding register is written with an invalid value, exception code 03 (Illegal Data Value) will be returned in the response message. You may refer to the Modbus specification for a complete list of possible error codes.

961EN-4006 Report Slave ID Example Response¹

FIELD	DESCRIPTION
Unit ID	Echo Unit ID Sent In Query
Function Code	11
Byte Count	42
Slave ID (Model No.)	00=961EN-4006 (6 Diff Current In w/Modbus) 01=962EN-4006 (6 Diff Voltage In w/Modbus)
Run Indicator Status	FFH (ON)
Firmware Number String (Additional Data Field)	41 43 52 4F 4D 41 47 2C 39 33 30 30 2D 31 32 31 2C 39 36 31 45 4E 2D 34 30 30 36 2C 30 31 32 33 34 35 41 2C 30 31 32 33 34 35 ("ACROMAG,9300- 118,961EN-4006 ,serial number&rev,six-byteMACID")

¹**Note:** For Model 962EN-4006, the slave ID is "01" and the firmware number is "9300-119".

For detailed information on Modbus, feel free to download our technical reference "Introduction To Modbus" at www.acromag.com.

Register Mirroring

For your convenience, 9xxEN Ethernet modules mirror the contents and operation of registers 0xxxx, 1xxxx, & 3xxxx (as applicable) into holding register space for systems and controllers that cannot directly access registers 0xxxx, 1xxxx, & 3xxxx.

All Modbus registers of this model can now be written to, or read from, using either the standard methods described in the Modbus specification, or through mapping (mirroring) to the Holding Registers. The registers are mapped as follows and specifics follow the mapping:

0xxxx Coil Registers are mapped to 42xxx Holding Registers
 1xxxx Input Status Registers are mapped to 41xxx Holding Registers
 3xxxx Input Registers are mapped to 43xxx Holding Registers

Register Mirroring

For 3xxxx Input Registers, the format of the registers are identical and you only need to offset your address by 43000. For example: if you want to read Input Register 1 through the Holding Registers, you would use the "Read Holding Registers" function with an address of 43001.

For the 1xxxx Input Status Registers (where supported), the return data is reformatted to match the Holding Register format. For example: if you request the Input Status for 12 digital inputs, instead of getting 2 bytes returned with the first 12 bits representing the 12 digital inputs, you will get 12 separate words, each set to either 0000H (OFF), or FFFFH (ON).

For the 0xxxx Coil Registers (where supported), reads are handled in the same way as the 1xxxx Input Status Registers. You can also write to the coil registers by using the "Preset Single Register" function with an address offset of 42000. Setting the data to 0000H will turn the coil OFF, while setting the data to FF00H will turn the coil ON. Writing to multiple coils is not supported via register mirroring, you must use the "Write Multiple Coils" function for that.

Note that with respect to Acromag 9xxMB Modbus RTU modules, only 3xxxx Input Registers are mirrored into 4xxxx space, not Coil or Input Status registers as noted here for 9xxEN models.

I/O values for Series 900EN modules are represented by the following simple data types for temperature, percentage, and discrete on/off.

Data Types

Summary Of Data Types Used By 900MB/900EN Modules

Data Types	Description
Normalized Data Count (This Model)	A 16-bit signed integer value is used to represent ±20000 counts for bipolar input ranges and 0-20000 counts for unipolar input ranges. For example, -5V, 0V and +5V are represented by integer values -20000, 0, and 20000 for bipolar devices, respectively.
Temperature	A 16-bit signed integer value with resolution of 0.1°C/lb represents the range of a TC type measured in degrees C. A 16-bit signed integer value with resolution of 0.1°C/lb. For example, a value of 12059 is equivalent to 1205.9°C, a value of -187 equals -18.7°C
Discrete	A discrete value is generally indicated by a single bit of a 16-bit word. The bit number/position typically corresponds to the discrete channel number. Unless otherwise defined for outputs, a 1 bit means the corresponding output is closed or ON, a 0 bit means the output is open or OFF. For inputs, a value of 1 means the input is ON (Active low near 0V), while a value of 0 specifies the input is OFF or in its high state (usually >> 0V).

Register Map

Model 961EN-4006 Model 962EN-4006

The following table outlines the register map for the Model 961EN-4006 and 962EN-4006 network input modules. The Modbus functions operate on these registers using the data types noted above (except for the Reset Slave and Report Slave ID functions). Unless otherwise noted, Holding Register values are maintained in flash memory and are non-volatile.

Ref	Addr.	Description	Data Type/Format																														
Input Registers (3x References, Read-Only)																																	
30001	0000	Module Status	Bit 15: 0 (Not Used) Bit 14: Wink Mode Flag 1 = Wink Mode (Blinks Run LED for ID) 0 = Normal Operation (See Wink Module Register) Bit 13: Default Mode Flag 1 = Default Mode Indicator 0 = Not Default Mode Bits 12-0: 0 (Not Used)																														
30002	0001	Input Range (CH 0,1,2)	Bits 15-4: 0 (Not Used) Bits <u>3,2,1,0:</u> <table style="display: inline-table; vertical-align: top; border: none;"> <tr> <td></td> <td><u>961EN</u></td> <td><u>962EN</u></td> </tr> <tr> <td>0000</td> <td>0=0-20mA</td> <td>0=±10V</td> </tr> <tr> <td>0001</td> <td>1=4-20mA</td> <td>1=±5V</td> </tr> <tr> <td>0010</td> <td>2=0-11.17mA</td> <td>2=±2.5V</td> </tr> <tr> <td>0011</td> <td>3=0-1mA</td> <td>3=±1.25V</td> </tr> <tr> <td>0100</td> <td><i>Reserved</i></td> <td>4=±625mV</td> </tr> <tr> <td>0101</td> <td><i>Reserved</i></td> <td>5=±313mV</td> </tr> <tr> <td>0110</td> <td><i>Reserved</i></td> <td>6=±156mV</td> </tr> <tr> <td>0111</td> <td><i>Reserved</i></td> <td>7=±78mV</td> </tr> <tr> <td>1000-1111</td> <td><i>Reserved</i></td> <td></td> </tr> </table>		<u>961EN</u>	<u>962EN</u>	0000	0=0-20mA	0=±10V	0001	1=4-20mA	1=±5V	0010	2=0-11.17mA	2=±2.5V	0011	3=0-1mA	3=±1.25V	0100	<i>Reserved</i>	4=±625mV	0101	<i>Reserved</i>	5=±313mV	0110	<i>Reserved</i>	6=±156mV	0111	<i>Reserved</i>	7=±78mV	1000-1111	<i>Reserved</i>	
	<u>961EN</u>	<u>962EN</u>																															
0000	0=0-20mA	0=±10V																															
0001	1=4-20mA	1=±5V																															
0010	2=0-11.17mA	2=±2.5V																															
0011	3=0-1mA	3=±1.25V																															
0100	<i>Reserved</i>	4=±625mV																															
0101	<i>Reserved</i>	5=±313mV																															
0110	<i>Reserved</i>	6=±156mV																															
0111	<i>Reserved</i>	7=±78mV																															
1000-1111	<i>Reserved</i>																																
30003	0002	Input Range (CH 3,4,5)	<i>Format is same as Above.</i>																														
30004	0003	CH00 Status	Bits 15-2: 0 (Not Used) Bits 1,0: <u>Input Signal Status</u> 00 In Range 01 Over-Range 10 Under-Range 11 Not Used																														
30005	0004	CH01 Status	Bits 15-2: 0 (Not Used) Bits 1,0: <u>Input Signal Status</u> 00 In Range 01 Over-Range 10 Under-Range 11 Not Used																														
30006	0005	CH02 Status	Bits 15-2: 0 (Not Used) Bits 1,0: <u>Input Signal Status</u> 00 In Range 01 Over-Range 10 Under-Range 11 Not Used																														

Register Map

Model 961EN-4006
Model 962EN-4006

Ref	Addr.	Description	Data Type/Format
Input Registers (3x References, Read-Only)			
30007	0006	CH03 Status	<u>Bits 15-2:</u> 0 (Not Used) <u>Bits 1,0:</u> <u>Input Signal Status</u> 00 In Range 01 Over-Range 10 Under-Range 11 Not Used
30008	0007	CH04 Status	<u>Bits 15-2:</u> 0 (Not Used) <u>Bits 1,0:</u> <u>Input Signal Status</u> 00 In Range 01 Over-Range 10 Under-Range 11 Not Used
30009	0008	CH05 Status	<u>Bits 15-2:</u> 0 (Not Used) <u>Bits 1,0:</u> <u>Input Signal Status</u> 00 In Range 01 Over-Range 10 Under-Range 11 Not Used
30010	0009	CH00 Value	Count
30011	000A	CH01 Value	Count
30012	000B	CH02 Value	Count
30013	000C	CH03 Value	Count
30014	000D	CH04 Value	Count
30015	000E	CH05 Value	Count
30016	000F	CH00 Count	Raw A/D Count Value
30017	0010	CH01 Count	Raw A/D Count Value
30018	0011	CH02 Count	Raw A/D Count Value
30019	0012	CH03 Count	Raw A/D Count Value
30020	0013	CH04 Count	Raw A/D Count Value
30021	0014	CH05 Count	Raw A/D Count Value
Holding Registers (4x References, Read/Write)			
40001	0000	Input Range (CH 0,1,2)	<u>Bits 15-4:</u> 0 (Not Used) Bits <u>3,2,1,0:</u> <u>961EN</u> <u>962EN</u> 0000 0=0-20mA 0=±10V 0001 1=4-20mA 1=±5V 0010 2=0-11.17mA 2=±2.5V 0011 3=0-1mA 3=±1.25V 0100 <i>Reserved</i> 4=±625mV 0101 <i>Reserved</i> 5=±313mV 0110 <i>Reserved</i> 6=±156mV 0111 <i>Reserved</i> 7=±78mV 1000-1111 <i>Reserved</i>
40002	0001	Input Range (CH 3,4,5)	Format is same as Above.

Note: Changes to Holding Registers take effect immediately.

Register Map

Model 961EN-4006

Model 962EN-4006

Note: Changes to Holding Registers take effect immediately.

Ref	Addr.	Description	Data Type/Format
Holding Registers (4x References, Read/Write)			
40003	0002	Reserved	Do Not Use
40004	0003	Reserved	Do Not Use
40005	0004	Reserved	Do Not Use
40006	0005	Reserved	Do Not Use
40007	0006	Reserved	Do Not Use
40008	0007	Port 0 Scaling Low	Reserved For Factory Use - Do Not Use
40009	0008	Reserved	Do Not Use
40010	0009	Port 0 Scaling High	Reserved For Factory Use - Do Not Use
40011	000A	Reserved	Do Not Use
40012	000B	Port 1 Scaling Low	Reserved For Factory Use - Do Not Use
40013	000C	Reserved	Do Not Use
40014	000D	Port 1 Scaling High	Reserved For Factory Use - Do Not Use
40015	000E	Reserved	Do Not Use
40016	000F	Reserved	Do Not Use
40017	0010	Reserved	Do Not Use
40018	0011	Reserved	Do Not Use
40019	0012	Reserved	Do Not Use
40020	0013	Reserved	Do Not Use
40021	0014	Calibration Access And Wink Mode Toggle And Restore Factory Calibration And Factory Use Only <i>This register is not maintained in flash.</i>	Writing 24106 (5E2AH) here immediately removes write protection from the calibration registers that follow. All other values apply write protection to the calibration registers (except 21845, 44718, and 43981--See Below). Writing 21845 (5555H) to this register will cause the module to "Wink" its Run LED. Writing this value a second time will stop "Wink" (Toggles Wink ON/OFF). Writing 44718 (AEA EH) will cause the module to restore its factory calibration. This can only be done after "Save Factory Calibration" has been done at the factory. Writing 43981 (ABCDH) is reserved for factory use. This should not be performed by anyone else or operation will be degraded. This register always reads back 0. After a reset, this register is set back to 0 (write protection enabled and no wink).

Ref	Addr.	Description	Data Type/Format
Holding Registers (4x References, Read/Write)			
40022	0015	CH0 Cal Hi Range 0	Raw A/D Count Value . 0-20mA (961EN) or ±10V (962EN)
40023	0016	CH0 Cal Lo Range 0	Raw A/D Count Value . 0-20mA (961EN) or ±10V (962EN)
40024	0017	CH0 Cal Hi Range 1	Raw A/D Count Value . 4-20mA (961EN) or ±5V (962EN)
40025	0018	CH0 Cal Lo Range 1	Raw A/D Count Value . 4-20mA (961EN) or ±5V (962EN)
40026	0019	CH0 Cal Hi Range 2	Raw A/D Count Value . 0-11.17mA (961EN) or ±2.5V (962EN)
40027	001A	CH0 Cal Lo Range 2	Raw A/D Count Value . 0-11.17mA (961EN) or ±2.5V (962EN)
40028	001B	CH0 Cal Hi Range 3	Raw A/D Count Value . 0-1mA (961EN) or ±1.25V (962EN)
40029	001C	CH0 Cal Lo Range 3	Raw A/D Count Value . 0-1mA (961EN) or ±1.25V (962EN)
40030	001D	CH0 Cal Hi Range 4	Raw A/D Count Value . ±625mV (962EN)
40031	001E	CH0 Cal Lo Range 4	Raw A/D Count Value . ±625mV (962EN)
40032	001F	CH0 Cal Hi Range 5	Raw A/D Count Value . ±313mV (962EN)
40033	0020	CH0 Cal Lo Range 5	Raw A/D Count Value . ±313mV (962EN)
40034	0021	CH0 Cal Hi Range 6	Raw A/D Count Value . ±156mV (962EN)
40035	0022	CH0 Cal Lo Range 6	Raw A/D Count Value . ±156mV (962EN)
40036	0023	CH0 Cal Hi Range 7	Raw A/D Count Value . ±78mV (962EN)
40037	0024	CH0 Cal Lo Range 7	Raw A/D Count Value . ±78mV (962EN)
40038	0025	CH1 Cal Hi Range 0	Raw A/D Count Value . 0-20mA (961EN) or ±10V (962EN)
40039	0026	CH1 Cal Lo Range 0	Raw A/D Count Value . 0-20mA (961EN) or ±10V (962EN)
40040	0027	CH1 Cal Hi Range 1	Raw A/D Count Value . 4-20mA (961EN) or ±5V (962EN)
40041	0028	CH1 Cal Lo Range 1	Raw A/D Count Value . 4-20mA (961EN) or ±5V (962EN)
40042	0029	CH1 Cal Hi Range 2	Raw A/D Count Value . 0-11.17mA (961EN) or ±2.5V (962EN)
40043	002A	CH1 Cal Lo Range 2	Raw A/D Count Value . 0-11.17mA (961EN) or ±2.5V (962EN)
40044	002B	CH1 Cal Hi Range 3	Raw A/D Count Value . 0-1mA (961EN) or ±1.25V (962EN)
40045	002C	CH1 Cal Lo Range 3	Raw A/D Count Value . 0-1mA (961EN) or ±1.25V (962EN)
40046	002D	CH1 Cal Hi Range 4	Raw A/D Count Value . ±625mV (962EN)

Register Map

Model 961EN-4006
Model 962EN-4006

Shaded 4xxxx register entries are Read Only

Register Map

Model 961EN-4006 Model 962EN-4006

Shaded 4xxxx register entries
are Read-Only.

Ref	Addr.	Description	Data Type/Format
Holding Registers (4x References, Read/Write)			
40047	002E	CH1 Cal Lo Range 4	Raw A/D Count Value . ±625mV (962EN)
40048	002F	CH1 Cal Hi Range 5	Raw A/D Count Value . ±313mV (962EN)
40049	0030	CH1 Cal Lo Range 5	Raw A/D Count Value . ±313mV (962EN)
40050	0031	CH1 Cal Hi Range 6	Raw A/D Count Value . ±156mV (962EN)
40051	0032	CH1 Cal Lo Range 6	Raw A/D Count Value . ±156mV (962EN)
40052	0033	CH1 Cal Hi Range 7	Raw A/D Count Value . ±78mV (962EN)
40053	0034	CH1 Cal Lo Range 7	Raw A/D Count Value . ±78mV (962EN)
40054	0035	CH2 Cal Hi Range 0	Raw A/D Count Value . 0-20mA (961EN) or ±10V (962EN)
40055	0036	CH2 Cal Lo Range 0	Raw A/D Count Value . 0-20mA (961EN) or ±10V (962EN)
40056	0037	CH2 Cal Hi Range 1	Raw A/D Count Value . 4-20mA (961EN) or ±5V (962EN)
40057	0038	CH2 Cal Lo Range 1	Raw A/D Count Value . 4-20mA (961EN) or ±5V (962EN)
40058	0039	CH2 Cal Hi Range 2	Raw A/D Count Value . 0-11.17mA (961EN) or ±2.5V (962EN)
40059	003A	CH2 Cal Lo Range 2	Raw A/D Count Value . 0-11.17mA (961EN) or ±2.5V (962EN)
40060	003B	CH2 Cal Hi Range 3	Raw A/D Count Value . 0-1mA (961EN) or ±1.25V (962EN)
40061	003C	CH2 Cal Lo Range 3	Raw A/D Count Value . 0-1mA (961EN) or ±1.25V (962EN)
40062	003D	CH2 Cal Hi Range 4	Raw A/D Count Value . ±625mV (962EN)
40063	003E	CH2 Cal Lo Range 4	Raw A/D Count Value . ±625mV (962EN)
40064	003F	CH2 Cal Hi Range 5	Raw A/D Count Value . ±313mV (962EN)
40065	0040	CH2 Cal Lo Range 5	Raw A/D Count Value . ±313mV (962EN)
40066	0041	CH2 Cal Hi Range 6	Raw A/D Count Value . ±156mV (962EN)
40067	0042	CH2 Cal Lo Range 6	Raw A/D Count Value . ±156mV (962EN)
40068	0043	CH2 Cal Hi Range 7	Raw A/D Count Value . ±78mV (962EN)
40069	0044	CH2 Cal Lo Range 7	Raw A/D Count Value . ±78mV (962EN)
40070	0045	CH3 Cal Hi Range 0	Raw A/D Count Value . 0-20mA (961EN) or ±10V (962EN)
40071	0046	CH3 Cal Lo Range 0	Raw A/D Count Value . 0-20mA (961EN) or ±10V (962EN)

Ref	Addr.	Description	Data Type/Format
Holding Registers (4x References, Read/Write)			
40072	0047	CH3 Cal Hi Range 1	Raw A/D Count Value . 4-20mA (961EN) or $\pm 5V$ (962EN)
40073	0048	CH3 Cal Lo Range 1	Raw A/D Count Value . 4-20mA (961EN) or $\pm 5V$ (962EN)
40074	0049	CH3 Cal Hi Range 2	Raw A/D Count Value . 0-11.17mA (961EN) or $\pm 2.5V$ (962EN)
40075	004A	CH3 Cal Lo Range 2	Raw A/D Count Value . 0-11.17mA (961EN) or $\pm 2.5V$ (962EN)
40076	004B	CH3 Cal Hi Range 3	Raw A/D Count Value . 0-1mA (961EN) or $\pm 1.25V$ (962EN)
40077	004C	CH3 Cal Lo Range 3	Raw A/D Count Value . 0-1mA (961EN) or $\pm 1.25V$ (962EN)
40078	004D	CH3 Cal Hi Range 4	Raw A/D Count Value . $\pm 625mV$ (962EN)
40079	004E	CH3 Cal Lo Range 4	Raw A/D Count Value . $\pm 625mV$ (962EN)
40080	004F	CH3 Cal Hi Range 5	Raw A/D Count Value . $\pm 313mV$ (962EN)
40081	0050	CH3 Cal Lo Range 5	Raw A/D Count Value . $\pm 313mV$ (962EN)
40082	0051	CH3 Cal Hi Range 6	Raw A/D Count Value . $\pm 156mV$ (962EN)
40083	0052	CH3 Cal Lo Range 6	Raw A/D Count Value . $\pm 156mV$ (962EN)
40084	0053	CH3 Cal Hi Range 7	Raw A/D Count Value . $\pm 78mV$ (962EN)
40085	0054	CH3 Cal Lo Range 7	Raw A/D Count Value . $\pm 78mV$ (962EN)
40086	0055	CH4 Cal Hi Range 0	Raw A/D Count Value . 0-20mA (961EN) or $\pm 10V$ (962EN)
40087	0056	CH4 Cal Lo Range 0	Raw A/D Count Value . 0-20mA (961EN) or $\pm 10V$ (962EN)
40088	0057	CH4 Cal Hi Range 1	Raw A/D Count Value . 4-20mA (961EN) or $\pm 5V$ (962EN)
40089	0058	CH4 Cal Lo Range 1	Raw A/D Count Value . 4-20mA (961EN) or $\pm 5V$ (962EN)
40090	0059	CH4 Cal Hi Range 2	Raw A/D Count Value . 0-11.17mA (961EN) or $\pm 2.5V$ (962EN)
40091	005A	CH4 Cal Lo Range 2	Raw A/D Count Value . 0-11.17mA (961EN) or $\pm 2.5V$ (962EN)
40092	005B	CH4 Cal Hi Range 3	Raw A/D Count Value . 0-1mA (961EN) or $\pm 1.25V$ (962EN)
40093	005C	CH4 Cal Lo Range 3	Raw A/D Count Value . 0-1mA (961EN) or $\pm 1.25V$ (962EN)
40094	005D	CH4 Cal Hi Range 4	Raw A/D Count Value . $\pm 625mV$ (962EN)
40095	005E	CH4 Cal Lo Range 4	Raw A/D Count Value . $\pm 625mV$ (962EN)

Register Map

Model 961EN-4006
Model 962EN-4006

Shaded 4xxxx register entries are Read-Only.

Register Map

Model 961EN-4006 Model 962EN-4006

Shaded 4xxxx register entries
are Read-Only.

Ref	Addr.	Description	Data Type/Format
Holding Registers (4x References, Read/Write)			
40096	005F	CH4 Cal Hi Range 5	Raw A/D Count Value . ±313mV (962EN)
40097	0060	CH4 Cal Lo Range 5	Raw A/D Count Value . ±313mV (962EN)
40098	0061	CH4 Cal Hi Range 6	Raw A/D Count Value . ±156mV (962EN)
40099	0062	CH4 Cal Lo Range 6	Raw A/D Count Value . ±156mV (962EN)
40100	0063	CH4 Cal Hi Range 7	Raw A/D Count Value . ±78mV (962EN)
40101	0064	CH4 Cal Lo Range 7	Raw A/D Count Value . ±78mV (962EN)
40102	0065	CH5 Cal Hi Range 0	Raw A/D Count Value . 0-20mA (961EN) or ±10V (962EN)
40103	0066	CH5 Cal Lo Range 0	Raw A/D Count Value . 0-20mA (961EN) or ±10V (962EN)
40104	0067	CH5 Cal Hi Range 1	Raw A/D Count Value . 4-20mA (961EN) or ±5V (962EN)
40105	0068	CH5 Cal Lo Range 1	Raw A/D Count Value . 4-20mA (961EN) or ±5V (962EN)
40106	0069	CH5 Cal Hi Range 2	Raw A/D Count Value . 0-11.17mA (961EN) or ±2.5V (962EN)
40107	006A	CH5 Cal Lo Range 2	Raw A/D Count Value . 0-11.17mA (961EN) or ±2.5V (962EN)
40108	006B	CH5 Cal Hi Range 3	Raw A/D Count Value . 0-1mA (961EN) or ±1.25V (962EN)
40109	006C	CH5 Cal Lo Range 3	Raw A/D Count Value . 0-1mA (961EN) or ±1.25V (962EN)
40110	006D	CH5 Cal Hi Range 4	Raw A/D Count Value . ±625mV (962EN)
40111	006E	CH5 Cal Lo Range 4	Raw A/D Count Value . ±625mV (962EN)
40112	006F	CH5 Cal Hi Range 5	Raw A/D Count Value . ±313mV (962EN)
40113	0070	CH5 Cal Lo Range 5	Raw A/D Count Value . ±313mV (962EN)
40114	0071	CH5 Cal Hi Range 6	Raw A/D Count Value . ±156mV (962EN)
40115	0072	CH5 Cal Lo Range 6	Raw A/D Count Value . ±156mV (962EN)
40116	0073	CH5 Cal Hi Range 7	Raw A/D Count Value . ±78mV (962EN)
40117	0074	CH5 Cal Lo Range 7	Raw A/D Count Value . ±78mV (962EN)
40118	0075	Ideal Range 0 Hi	Ideal A/D Count Value . 0-20mA (961EN) or ±10V (962EN)
40119	0076	Ideal Range 0 Lo	Ideal A/D Count Value . 0-20mA (961EN) or ±10V (962EN)
40120	0077	Ideal Range 1 Hi	Ideal A/D Count Value . 4-20mA (961EN) or ±5V (962EN)

Ref	Addr.	Description	Data Type/Format
Holding Registers (4x References, Read/Write)			
40121	0078	Ideal Range 1 Lo	Ideal A/D Count Value . 4-20mA (961EN) or ±5V (962EN)
40122	0079	Ideal Range 2 Hi	Ideal A/D Count Value . 0-11.17mA (961EN) or ±2.5V (962EN)
40123	007A	Ideal Range 2 Lo	Ideal A/D Count Value . 0-11.17mA (961EN) or ±2.5V (962EN)
40124	007B	Ideal Range 3 Hi	Ideal A/D Count Value . 0-1mA (961EN) or ±1.25V (962EN)
40125	007C	Ideal Range 3 Lo	Ideal A/D Count Value . 0-1mA (961EN) or ±1.25V (962EN)
40126	007D	Ideal Range 4 Hi	Ideal A/D Count Value . ±625mV (962EN)
40127	007E	Ideal Range 4 Lo	Ideal A/D Count Value . ±625mV (962EN)
40128	007F	Ideal Range 5 Hi	Ideal A/D Count Value . ±313mV (962EN)
40129	0080	Ideal Range 5 Lo	Ideal A/D Count Value . ±313mV (962EN)
40130	0081	Ideal Range 6 Hi	Ideal A/D Count Value . ±156mV (962EN)
40131	0082	Ideal Range 6 Lo	Ideal A/D Count Value . ±156mV (962EN)
40132	0083	Ideal Range 7 Hi	Ideal A/D Count Value . ±78mV (962EN)
40133	0084	Ideal Range 7 Lo	Ideal A/D Count Value . ±78mV (962EN)
40134	0085	Reserved	Do Not Use
40135	0086	Reserved	Do Not Use
40136	0087	Span Cal Register	A 16-Bit value whose bit position when set indicates the channel to be calibrated for span. For example: to calibrate span of channel 0, write 0001H to this register. To calibrate span of channel 5, write 0020H to this register. IMPORTANT: You must FIRST write 5E2AH into the Calibration Access Register (Register 40021) before attempting calibration.
40137	0088	Zero Cal Register	A 16-Bit value whose bit position when set indicates the channel to be calibrated for zero. For example: to calibrate zero of channel 0, write 0001H to this register. To calibrate zero of channel 5, write 0020H to this register. IMPORTANT: You must FIRST write 5E2AH into the Calibration Access Register (Register 40021) before attempting calibration.
43001 . .		This block Mirrors 3xxxx Registers.	Refer to Register Mirroring. 3xxxx Input Registers are mapped to the 43xxxx Holding Register space using an address offset of 43000.

Register Map

Model 961EN-4006
Model 962EN-4006

Shaded 4xxxx registers are Read-Only.

Register Map

Model 961EN-4006
Model 962EN-4006

Notes (Memory Map):

With 16-bit signed integers, a count of 0-7FFFH is a positive number, while 8000-FFFFH is a negative number. The $\pm 1V$ DC input range values are represented by ± 20000 counts. For example when using bipolar voltage devices (962EN), -1V, 0V, & +1V are represented by integer values -20000, 0, & +20000, respectively. Similarly, when connected to a unipolar current device (961EN), integer values from 0-20000 counts represent 0-1mA, excluding negative values.

SPECIFICATIONS

These DIN-rail mount, industrial Ethernet, analog input modules will condition up to six differential DC current (961EN), or voltage (962EN) input signals, and provide an isolated 10/100BaseT Ethernet port for monitoring and control. Units are DC-powered and include reverse polarity protection. Analog inputs (as a group), network, and power are isolated from each other. Non-volatile reprogrammable memory in the module stores configuration and calibration information.

Model Numbers

961EN-4006 (6 DC Current)
962EN-4006 (6 DC Voltage)

The BusWorks model prefix "900" denotes the Series 900 network I/O family. The "EN" suffix denotes EtherNet. Select 961EN for current input, and 962EN for voltage input. The four digit suffix of this model number represents the following options, respectively: "4" = Ethernet; "0" = Default; "06" = 6 Channels.

Analog Inputs

Up to six process current or voltage input channels, according to model number. The unit can be configured to accept one of several input ranges at each group of 3 channels as described below. The unit must be wired and configured for the intended input type and range (see Connections section for details). The following paragraphs summarize this model's input types, ranges, and applicable specifications.

DC Current (961EN Only): Configurable for 0 to 20mA, 4-20mA,

0-11.17mA, and 0-1mA DC nominal input ranges. A precision 24.9 Ω current sink resistor converts the input current to a voltage that is processed by the A/D converter. An optional external sensor is required to monitor AC current signals (Acromag Model 5020-350).

This sensor generates a DC milliamper signal of 0 to 11.17mA for the module (see Table 1 below for scaling to AC current).

Current Input Reference Test Conditions: 4 to 20mA current input; ambient temperature = 25°C; 24VDC supply.

Input Overvoltage Protection: Bipolar Transient Voltage Suppressors (TVS), 5.2V clamp level typical.

AC Current Sensor (Model 5020-350, For Use With 961EN): This sensor is a toroidal instrument transformer that converts a sinusoidal 50-60Hz AC current signal into a low level DC milliampere signal of 0 to 11.17mA. The input AC current range is a function of the number of turns placed through the toroid as shown in Table 1 below. This sensor is isolated and requires no calibration or adjustment. When used with a 961EN module, it provides redundant input isolation and may facilitate input-to-input isolation of this six channel unit.

Table 1: AC Current Sensor Turns & Range

AC Current Input Range	Primary Turns	Sensor Output (Red/Black Wires)
0 to 20A AC	1	0 to 11.17mA DC
0 to 10A AC	2	"
0 to 5A AC	4	"
0 to 2A AC	10	"
0 to 1A AC	20	"

The output wires of this sensor are polarized with red as (+) plus and black as (-) minus. Normally these output wires are attached to one end of a user supplied cable while the other end connects to the 961EN's process current input terminals.

Input Burden: A function of the wire gauge resistance used for primary turns (the current carrying wire being monitored).

AC Current Sensor to Transmitter Wiring Distance: 400 feet maximum for 18 gauge wire. Other wire gauges can be used as long as the resistance of both wires is less than 5Ω.

Input Overload: The AC current sensor will withstand overload conditions as follows:

- 20 times full scale for 0.01 seconds.
- 10 times full scale for 0.1 seconds.
- 5 times full scale for 1.0 second.

DC Voltage (962EN Only): A 10:1 input divider is installed at the input (utilizing divider resistor values of 100K and 10.5K). User-configurable for the nominal bipolar DC voltage ranges of ±10V, ±5V, ±2.5V, ±1.25V, ±625mV, ±313mV, ±156mV, and ±78mV DC.

Input Impedance: 110.5KΩ.

Voltage Input Reference Test Conditions: -10 to 10V DC input; ambient temperature = 25°C; 24VDC supply.

Input Overvoltage Protection: Bipolar Transient Voltage Suppressers (TVS), 18V clamp level typical.

Accuracy: Better than ±0.05% of span, typical for nominal input ranges (except 0-1mA). This includes the effects of repeatability, terminal point conformity, and linearization, but does not include sensor error.

Measurement Temperature Drift: Better than ±50ppm/°C (±0.005%/°C).

Analog to Digital Converter (A/D): A 16-bit Σ-Δ converter.

Resolution: 0.005% or 1 part in 20000 (961EN), 0.0025% or 1 part in 40000 (962EN, full bipolar range).

SPECIFICATIONS

Analog Inputs

General Specifications

General Specifications

Input Conversion Rate: 80ms per channel, or 480ms for six input channels.

Input Filter: Normal mode filtering, plus digital filtering optimized and fixed per input range within the Σ - Δ ADC.

Input Filter Bandwidth: -3dB at 3Hz, typical.

Noise Rejection (Normal Mode): 40dB @ 60Hz, typical with 100 Ω input unbalance.

Noise Rejection (Common Mode): 140dB @ 60Hz, typical with 100 Ω input unbalance.

Data Types: Input range - A 16-bit signed integer value with resolution of 0.005%/lsb. ± 20000 is used to represent $\pm 100\%$. For example, -100%, 0%, and +100% are represented by decimal values -20000, 0, and 20000, respectively.

Note: Channels 0, 1, & 2, and channels 3, 4, & 5 (every group of 3 channels) must share the same input configuration, but this configuration may vary between the two groups.

Enclosure & Physical

Dimensions: 1.05 inches wide, 4.68 inches tall, 4.35 inches deep. Refer to the dimensions drawing at the front of this manual.

DIN Rail Mount: Type EN50022; "T" rail (35mm).

I/O Connectors: Removable plug-in type terminal blocks rated for 15A/300V; AWG #12-24 stranded or solid copper wire.

Network Connector: 8-pin RJ-45 connector socket with metal shield (shield is bypassed to earth ground at the GND terminal via an isolation capacitor and TVS). Connections are wired MDI, as opposed to MDI-X. You must use a CAT-5 crossover cable to connect this module to a PC. Otherwise you may use an auto-crossing Ethernet switch, such as the Acromag 900EN-S005 to make connections.

RJ-45	Signal (MDI)	Description
1	Tx+	Transmit Positive
2	Tx-	Transmit Negative
3	Rx+	Receive Positive
4	Not Used	Connects to Pin 5
5	Not Used	Connects to Pin 4
6	Rx-	Receive Negative
7	Not Used	Connects to Pin 8
8	Not Used	Connects to Pin 7

Case Material: Self-extinguishing NYLON type 6.6 polyamide thermoplastic UL94 V-2, color beige; general purpose NEMA Type 1 enclosure.

Printed Circuit Boards: Military grade FR-4 epoxy glass.

Shipping Weight: 1 pound (0.45 Kg) packed.

Agency Approvals

Safety Approvals: : UL Listed (USA & Canada). Hazardous Locations-Class I, Division 2, Groups A, B, C, D. Consult factory.

ATEX Certified: Assessment by TUV Rheinland of North of America, Inc. per
ATEX Directive 94/9/EC.
Ex nA IIC T4 Gc
TUVNA 14 EX 0001X

x = Special Conditions

- 1) "WARNING-EXPLOSION HAZARD-DO NOT MAKE OR BREAK CONNECTIONS IN HAZARDOUS LOCATIONS OR AREAS"
- 2) "Warning: Must be installed in suitable enclosure with an Ingress Protection of IP54 minimum, in Hazardous Locations or Areas"

Operating Temperature: -25°C to +70°C (-13°F to +158°F).

Storage Temperature: -40°C to +85°C (-40°F to +185°F).

Relative Humidity: 5 to 95%, non-condensing.

Power Requirements: 15-36V DC SELV (Safety Extra Low Voltage), 2W.
Observe proper polarity. See table for current.

Supply	961/962EN-4006 Current Draw
15V	103mA Typical, 113mA Maximum
18V	86mA Typical, 95mA Maximum
24V	67mA Typical, 74mA Maximum
36V	50mA Typical, 55mA Maximum

CAUTION: Risk of Electric Shock – More than one disconnect switch may be required to de-energize equipment before servicing.

Isolation: Input channels (as a group), power, and network circuits are isolated from each other for common-mode voltages up to 250VAC, or 354V DC off DC power ground, on a continuous basis (will withstand 1500VAC dielectric strength test for one minute without breakdown). Complies with test requirements of ANSI/ISA-82.01-1988 for voltage rating specified.

Installation Category: Designed to operate in an installation in a Pollution Degree 2 environment with an installation category (over-voltage category) II rating.

Electromagnetic Interference Immunity (EMI): Unit has demonstrated measurement shift less than ±0.25% of input span with interference from switching solenoids, commutator motors, and drill motors.

Electromagnetic Compatibility (EMC) -

Immunity Per European Norm BS EN 61000-6-2:2005:

Electrostatic Discharge (ESD) Immunity: 4KV direct contact and 8KV air-discharge to the enclosure port per IEC61000-4-2.

Radiated Field Immunity (RFI): 10V/M, 80 to 1000MHz AM, 1.4 to 2GHz 3V/M, and 2 to 2.7GHz 1V/M, per IEC61000-4-3.

Electrical Fast Transient Immunity (EFT): 2KV to power, and 1KV to signal I/O per IEC61000-4-4.

Conducted RF Immunity (CRFI): 10V rms, 150KHz to 80MHz, per IEC61000-4-6.

Surge Immunity: 0.5KV per IEC61000-4-5.

Emissions Per European Norm BS EN 61000-6-4:2007

Radiated Frequency Emissions: 30 to 1000MHz per CISPR16 Class A

WARNING: This is a Class A product. In a domestic environment, this product may cause radio interference in which the user may be required to take adequate measures.

Environmental

CAUTION: Do not exceed 36VDC peak, to avoid damage to the module.

External Fuse: Select a high surge tolerant fuse rated for 1A or less to protect unit.

CAUTION: Risk of Electric Shock – More than one disconnect switch may be required to de-energize the equipment before servicing.

These limits represent the minimum requirements of the standard, but product has typically been tested to comply with higher standards in some cases.

Environmental

IMPORTANT: Power, input, and output (I/O) wiring must be in accordance with Class I, Division 2 wiring methods of Article 501-4(b) of the National Electrical Code, NFPA 70 for installations in the US, or as specified in section 18-1J2 of the Canadian Electrical Code for installations within Canada and in accordance with the authority having jurisdiction.

This equipment is suitable for use in Class I, Division 2, Groups A, B, C, and D, or non-hazardous locations only.

WARNING – EXPLOSION HAZARD – Substitution of any components may impair suitability for Class I, Division 2.

WARNING – EXPLOSION HAZARD – Do not disconnect equipment unless power has been switched off or the area is known to be non-hazardous.

EMC – CE Marked

Electromagnetic Compatibility (EMC): CE marked, per EMC Directive 2004/108/EC. Consult factory.

Immunity per BS EN 61000-6-2:

- 1) Electrostatic Discharge Immunity (ESD), per IEC 61000-4-2.
- 2) Radiated Field Immunity (RFI), per IEC 61000-4-3.
- 3) Electrical Fast Transient Immunity (EFT), per IEC 61000-4-4.
- 4) Surge Immunity, per IEC 61000-4-5.
- 5) Conducted RF Immunity (CRFI), per IEC 61000-4-6.

Emissions per BS EN 61000-6-4:

- 1) Enclosure Port, per CISPR 16.
- 2) Low Voltage AC Mains Port, Per CISPR 16.
- 3) Telecom / Network Port, per CISPR 22.

Ethernet Interface

Connector: Shielded RJ-45 socket, 8-pin, 10BaseT/100BaseTX.

Wiring: Wired MDI. Unit does NOT support auto-crossover.

Protocol: Modbus TCP/IP w/Web Browser Configuration.

IP Address: Default static IP address is 128.1.1.100.

Port: Up to 10 sockets supported. Uses port 502 (reserved for Modbus).

Transient Protection: Transient Voltage Suppressors (TVS) are applied differentially at the transmit and receive channels. Additionally, the metal shield is coupled to the earth ground terminal via an isolation capacitor and TVS.

Data Rate: Auto-sensed, 10Mbps or 100Mbps.

Duplex: Auto-negotiated, Full or Half Duplex.

Compliance: IEEE 802.3, 802.3u, 802.3x.

Modbus TCP/IP Protocol Support: Up to 10 sockets may be selected.

Web pages for configuration and control are built-in and may be accessed over Ethernet via a standard web browser. Most module functionality is configured via memory map registers or web pages, but some functionality may only be configured via web pages.

Rx/Tx Memory: 8K bytes internal SRAM memory for receive and transmit buffers (FIFO).

Communication Distance: The distance between two devices on an Ethernet network is generally limited to 100 meters using recommended copper cable. Distances may be extended using hubs, switches, or fiber optic transmission. However, the total round trip delay time must not exceed 512 bit times for collision detection to work properly with CSMA/CD (half-duplex).

Port Status Indicators: Green LED indicates link status (ON if auto-negotiation has successfully established a connection), yellow LED indicates activity (ethernet connection is busy/traffic is present).

Address: As shipped from the factory, the IP address is static and set to 128.1.1.100. The IP address may optionally be automatically acquired at startup. The unit may be configured to retrieve this address from the network server using BOOTP (Bootstrap Protocol), or via DHCP (Dynamic Configuration Protocol). It may also be preset by the user and loaded from internal non-volatile memory. The unit includes a default address toggle switch to cause the module to assume a preset default factory address.

LED Indicators:

RUN (Green) - Constant ON if power is on. Continuous flashing ON/OFF indicates unit is in "wink" ID mode.

ST (Yellow) - Blinks ON/OFF in default communication mode. Stays ON if an input is out of range.

LINK (Green) - Indicates Ethernet *link* status (ON if auto-negotiation has successfully established a connection).

ACT (Yellow) - Indicates Ethernet *activity* (Ethernet connection is busy/traffic is present).

Controls:

Reset/Default Address Switch: This momentary toggle switch is located on the front panel and is used to either reset the module (toggle right), or cause the module to assume a default IP address (toggle left). Module address is initially set to 128.1.1.100 at the factory, or may be preset by the user. This switch can also be used to restore the module to its initial factory configuration by holding this switch in its default position while powering up the unit (see "Getting Out Of Trouble" in the Troubleshooting section for more information).

The minimum cable required for full operation of this device is Category 5. The term "Category" refers to classifications of UTP (Unshielded Twisted Pair) and STP (Shielded Twisted Pair) cables. There are 3 main categories of cable - Category 3, Category 4, and Category 5. The differences in classification is found in their electrical performance and this is documented in the TIA/EIA 568-A standard.

This device is designed for use in harsh industrial environments. Acromag recommends the use of shielded cable when wiring to this device. Select STP (Shielded Twisted Pair) cable rather than UTP (Unshielded Twisted Pair). The use of shielded cable will help protect the data being transmitted from harmful EMI (Electromagnetic Interference) and RFI (Radio Frequency Interference). It will also help to lower your radiated emissions by keeping the cable from emitting EMI and RFI.

There are two types of cable conductors: solid cable and stranded cable. Stranded cables are more flexible than solid cables. But since attenuation is higher for stranded cables than solid conductor cables, these are generally reserved for short runs and patch applications less than 6 meters.

Currently there are two types of shielding employed in Category 5 STP cable: single-shielded and double-shielded. Both of these cables have the same core and jacket as UTP cables, but also include a thin foil outer shield that covers all four twisted-wire pairs. Variations may include a drain wire that encircles the outer jacket. A double-shielded version adds an outer wire screen that surrounds the foil shield and also functions as a drain wire. The drain wire or wire screen typically makes contact at each end of the cable with the metal shield around special RJ45 plug connectors. This shield then

Refer to Acromag Application Note 8500-734 for instructions on how to change the IP address of your PC network interface card in order to talk to an Acromag module.

Controls & Indicators

ACCESSORY CABLES

makes contact with the metal shield of shielded RJ45 sockets. The socket shield may make direct contact with earth ground, or it may be capacitively coupled to earth ground. In the Acromag 9xxEN modules, it makes contact with earth ground via a high voltage capacitor and transient voltage suppressor. In addition to separately isolating the shield, this helps to minimize radio frequency and electromagnetic interference, and has the added benefit of protection from ESD (Electro-Static Discharge).

Further, Acromag recommends the use of *enhanced* Category 5 cable (CAT-5e). This cable has all the characteristics of Category 5, but includes enhancements that help to minimize crosstalk. Category 5e cable has a greater number of turns-per-inch in its twisted pairs and its performance is also more suitable for applications that make use of all four wire pairs for simultaneous bidirectional data transmission (full-duplex). As such, it is rated for frequencies up to 200MHz, double the rate of Category 5. This cable is defined in TIA/EIA-568A-5 (Addendum 5).

Acromag offers the following cable accessories for use with this module:

Cable Model 5035-355 – A yellow, 3 foot long, single-shielded Category 5e STP patch cable with drain wire and an RJ45 plug at both ends. Use this cable to connect an Acromag 9xxEN I/O module to the Acromag 900EN-S005 switch.

Cable Model 5035-360 – A green, 5 foot long, single-shielded Category 5e STP crossover cable with a drain wire and an RJ45 plug at both ends. This cable performs the Ethernet crossover function and is used to connect a PC directly to an Acromag Series 9xxEN I/O module.

Note that you do not need to use a crossover cable to connect your PC to this module if the Acromag 900EN-S005 switch is used between the PC and module, as the switch is auto-crossing. However, you must use a crossover cable when directly connecting your PC to a Series 9xxEN I/O Module without the use of an auto-crossing switch or hub.

You may obtain cable in other lengths and colors as required for your application from other vendors. For example, shielded CAT-5e cable is available from the following vendors:

- L-com Connectivity Products, www.L-com.com
- Pro-Link, www.prolink-cables.com

For very noisy environments or in the presence of strong electrical fields, you can obtain double-shielded CAT-5e cable and shielded RJ45 plugs from the following vendors:

- L-com Connectivity Products, www.L-com.com, see cable model TFSC2004 and shielded plug T8P8CSR.
- Regal Electronics, www.regalusa.com, see shielded plug model 1003B-8P8CSR-C5.

Complete premium double-shielded Category 5e standard and crossover cables in variable lengths can be obtained from Lumberg at www.lumbergusa.com (refer to their etherMate line). For example, specify RJ45S-RJ45S-656/B/3M for a double-shielded, 3 meter straight cable. Specify RJ45S-RJ45S-656/BX/3M for a double-shielded, 3 meter crossover cable.

Patch Cable & Crossover Cable

Revision History

The following table shows the revision history for this document:

Release Date	Version	EGR/DOC	Description of Revision
21 JUN 12	G	TPH/KLK	Updated input over/under range specifications (ECN 12A011).
04 JAN 13	H	CAP/BNB	Added ATEX and updated CE specifications (ECN 12L019).
21 APR 14	J	CAP/SRW	Update ATEX per latest standards (ECO 14D012).
09 JAN 2019	K	CAP/ARP	Update "WARNING - EXPLOSION HAZARD - Substitution of <u>any</u> components..." per uL.