



Modbus/RS-485



932/934MB Multi-Channel Temperature Control Modules

RTD or Resistance Input

Limit Alarms or Discrete Outputs

Models

932MB: 2 input channels, 2 relay outputs

934MB: 4 input channels, 4 relay outputs

Input

RTD (100 ohm Pt, 120 ohm Ni, 10 ohm Cu), Resistance (0 to 500 ohms)

Output

Solid-state relays, Form A, SPST-NO

Network Communication

Modbus-RTU high-speed RS-485

Power Requirement

10 to 36V DC,
24V AC

Approvals

CE marked. UL, cUL listed
Class I; Division 2; Groups A, B, C, D.

RTD/Resistance Input Module

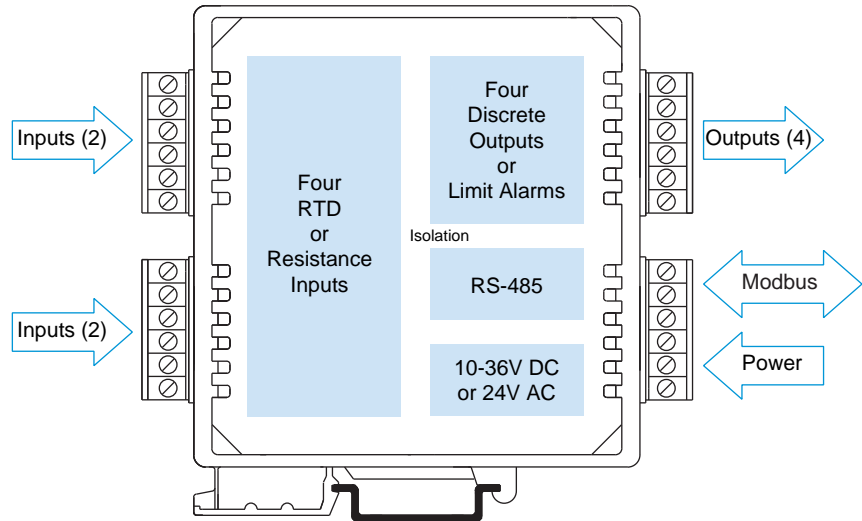

Description

This signal conditioner is a dual or quad-channel analog input module with one discrete/relay output per input channel and a Modbus interface. It filters and linearizes RTD or resistance inputs while providing isolation between input, output, power, and network circuits. Lead wire compensation and upscale/downscale sensor break detection are standard. Low voltage AC and DC power sources are supported with nonpolarized, diode-coupled terminals.

The programmable inputs accommodate four RTD types plus wide-range resistance signals. Flexible discrete outputs operate as alarms or on/off controllers. As limit alarms, each discrete output can be configured with high and/or low setpoints exclusively tied to an analog input channel. Alarm trips function without host communication enabling low-cost stand-alone alarms as well as local backup for the primary control system. Otherwise, on/off control is based on commands issued by the host system.

Combining flexible transmitter functions, mixed signal I/O, alarm support, and a network interface in a single package, makes this instrument extremely powerful. Multi-channel design adds cost-efficiency and allows high-density mounting. Plus, safe, rugged construction makes these modules reliable for use in both control room and distributed field I/O applications. Custom module configurations are also possible (consult factory for details).

Special Features

- Standard Modbus RTU protocol with high-speed RS-485 communication (up to 115K bps)
- 16-bit sigma-delta A/D yields 0.1°C resolution and 0.25°C accuracy (Pt, Ni RTDs)
- RTD linearization and sensor break detection ensure reliable measurements
- Discrete relay outputs enable local temperature limit alarms or host-controlled on/off switching
- Heavy-duty 1A solid-state relays provide dependable on/off control of industrial devices
- Self-calibration lowers maintenance costs by reducing periodic manual calibration checks
- Watchdog timers provide a configurable failsafe output state for use when host I/O communication is lost
- Four-way isolation eliminates potential ground loops between power, input, output and network circuitry
- Self-diagnostics monitor microcontroller activity to detect operational failures (lock-up) and execute a reset to restore communication



Performance

RTD/Resistance Input

Input Ranges

Input type user-configured. Type selected applies to all channels. RTD linearization, lead wire compensation, and open circuit or lead break detection are included.

Input Type	Alpha	Input Range	Accuracy
Pt 100 ohm	1.3850	-200 to 850°C	±0.25°C
Pt 100 ohm	1.3911	-200 to 850°C	±0.25°C
Ni 120 ohm	1.6720	-80 to 320°C	±0.25°C
Cu 10 ohm	1.4272	-200 to 260°C	±1.00°C
Resistance	linear	0 to 500 ohms	±0.05 ohm

Resolution

Input Type	Alpha	Resolution
Pt 100 ohm	1.3850	0.1°C
Pt 100 ohm	1.3911	0.1°C
Ni 120 ohm	1.6720	0.1°C
Cu 10 ohm	1.4272	0.2°C
Resistance	linear	7.8125 milliohms

Ambient Temperature Effect

Better than ±0.005% of input span per °C, or ±1.0uV/°C, whichever is greater.

Noise Rejection

Normal mode: 40dB @ 60Hz, typical.
Common mode: 130dB @ 60Hz, typical.

Input Filter Bandwidth

-3dB at 3Hz, typical.

Input Conversion Rate

300ms per channel typical.

RTD Break Detection

Sensor failure can be configured for either upscale or downscale. Selection applies to all channels.

Excitation Current

1mA DC typical, all types.

Lead-Wire Compensation

Inherent for 3-wire RTD. The maximum lead resistance is 25 ohms per lead (Pt), 20 ohms per lead (Ni), 10 ohms per lead (Cu). All lead wires must be of equal size and length.

Discrete Output

Output Type

Solid-State Relay (SSR), one Form A (SPST-NO) switch per input channel. Outputs share a common return connection at the RTN terminals for low side switching

Output Voltage Range

0 to 48V DC, 1A DC.

Output ON Resistance

0.4 ohms maximum.

Output Response Time

4.1ms typical, from receipt of command to gate transition of the output MOSFET.

Operation

Digital outputs are set to their OFF state following a software or power-on reset. Outputs can be set to user-defined states following a watchdog timeout.

Communication

Supported Modbus Commands

The command/response protocol for communicating with this module adheres to the Modbus/RTU standard for the following Modbus Functions.

Read Holding Registers	Read Coil
Read Input Registers	Reset Slave
Preset Single Register	Report Slave ID
Force Multiple Coils	Force Single Coil
Preset Multiple Register	

LED Indicators

LEDs indicate power, status, and discrete level/alarm.

Power and Isolation

Power Requirements

10 to 36V DC (56mA max. at 24V DC).
22 to 26V AC (94mA rms max. at 24V AC).

Isolation

1500V AC for 60 seconds or 250V AC continuous. 4-way isolation between input, network, power and discrete I/O circuits. Inputs are isolated channel-to-channel for common mode voltage to ±5V DC.

Ordering Information

932MB-0900

Two channel RTD/Resistance input module

934MB-0900

Four channel RTD/Resistance input module

Accessories

900C-SIP

Configuration Software Interface Package (includes software CD-ROM for Windows, RS-232/485 converter, and RS-485/three-wire cable)

4001-095

USB-to-RS232 adapter. See page 70 for more info.

TBK-B02

Optional terminal block kit, barrier strip style, 4 pcs.

TBK-S02

Optional terminal block kit, spring clamp style, 4 pcs.

PS5R-D24

Power supply (24V DC, 2.1A).
See Power Supplies on Page 199.

For more information on software, network hardware, and mounting accessories, please see Pages 69-71.

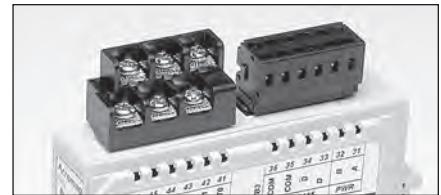

Optional terminal blocks: barrier strip (left) and spring clamp (right). Cage clamp terminal is standard.

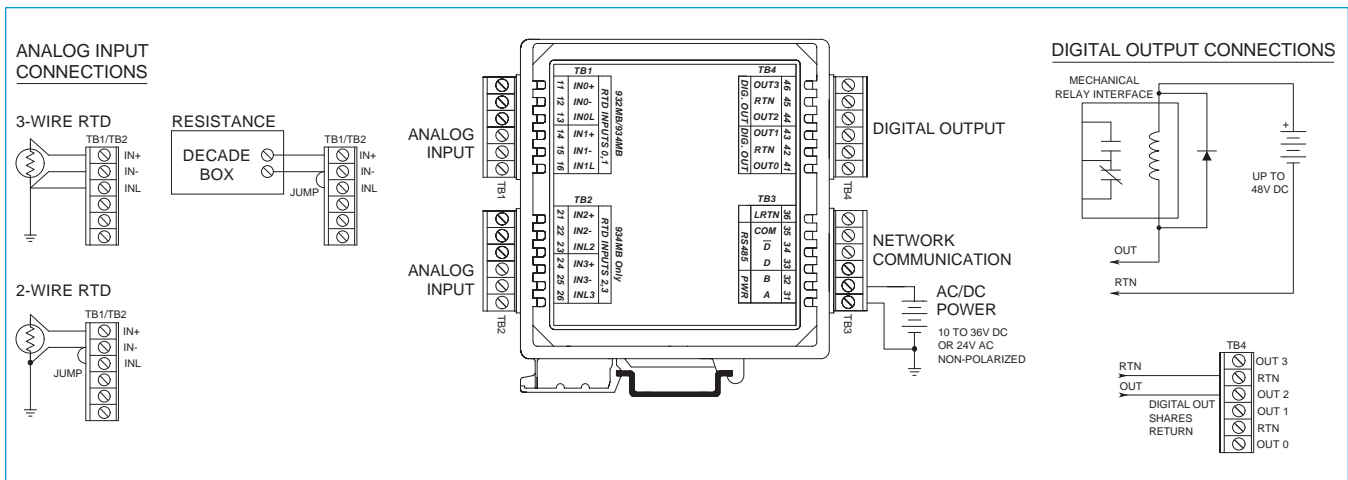



900MB Series Technical Diagrams

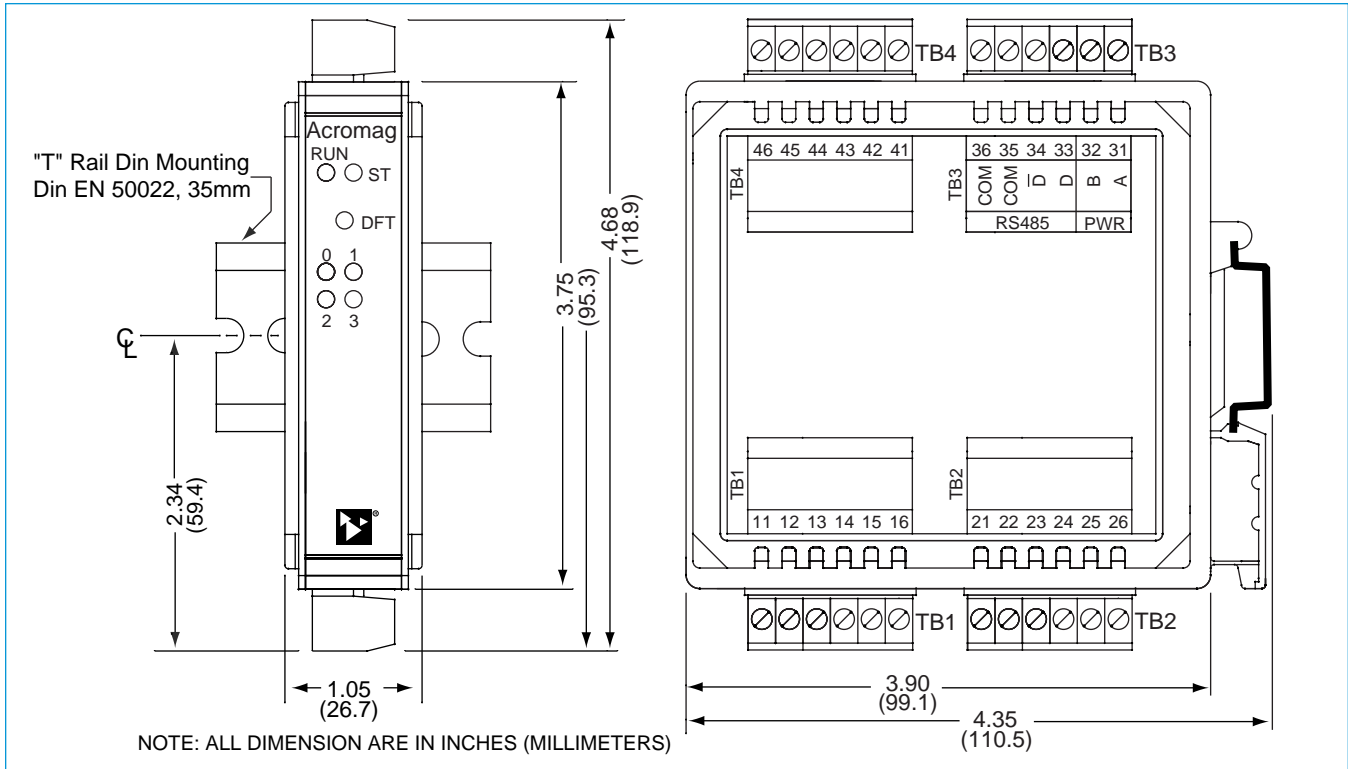

PERSONAL COMPUTER
W/ WINDOWS 95/98 OR NT



INSTALL MODBUS CONFIGURATION SOFTWARE

RS-232 SERIAL PORT CONNECTOR AT BACK OF PC

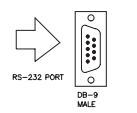

RS-232 TO RS-485 CONVERTER MODEL 5034-214

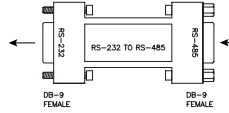

CONNECT THE RS-232 SIDE OF CONVERTER TO THE PC

CABLE 5034-202

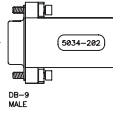

CONNECT THE RS-485 SIDE OF CONVERTER TO THE CABLE

CAUTION: DO NOT CONNECT THE CABLE DIRECTLY TO THE PC WITHOUT THE CONVERTER, OR DAMAGE TO THE MODULE MAY RESULT.

900C-SIP COMMUNICATION CONNECTIONS

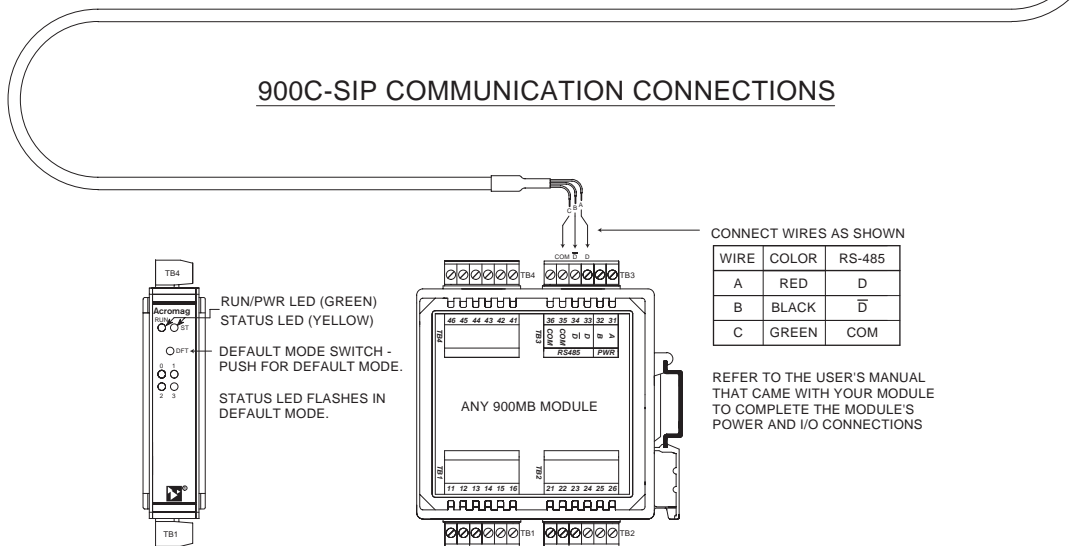



Configuration Kit

Software Interface Package
Model No. 900C-SIP

RS-485 Cable (DB-9)

RS-232 to RS-485 Converter (non-isolated)

Configuration Software for Windows

Software Interface Package

This package includes Windows® Configuration Software, an RS-232-to-485 Serial Port Converter, and an RS-485 Signal Cable. These components provide everything you need to set up a Series 900 I/O module from your desktop PC before installing it on the network.

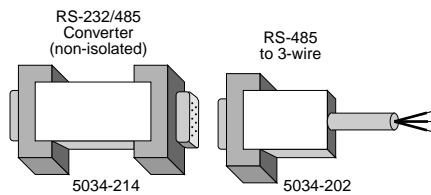

Ordering Information

- 900C-SIP
Software Interface Package.
Includes Configuration Software (5034-186), Non-isolated RS-232 to RS-485 Serial Port Converter (5034-214), and RS-485 Cable (5034-202).
Items can also be ordered separately below.
- 5034-186
Configuration Software for Windows (95/98/2000/ME/NT4/XP) on CD-ROM.
- 5034-214
Non-isolated RS-232 to RS-485 Serial Port Converter, DB-9F to DB-9F.
- 5034-202
RS-485 to 3-wire Cable Converter, DB-9M to 3 x 12AWG RS-485 Cable, 8 ft.

Network Power

CE UL US LISTED TUV

Universal 50W Power Supply

The PS5R-D24 is the ideal power source to drive your network.

Input Power Requirement
Universal power
85 to 264V AC,
105 to 370V DC

Output
24V DC, 2.1A (50W)

Ordering Information

PS5R-D24
Universal Power Supply

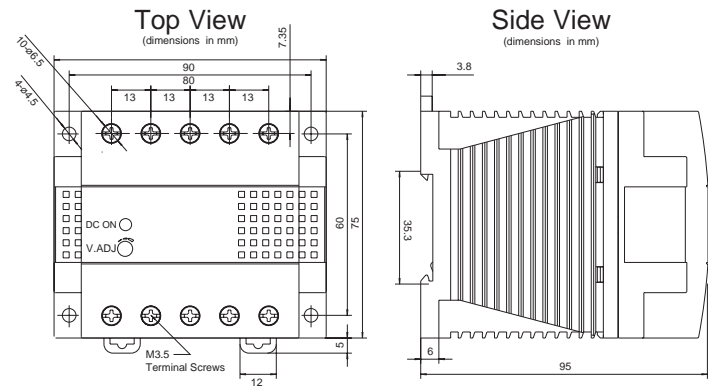

Mounting Hardware

DIN-Rail Mounting

For your convenience, Acromag offers several mounting accessories to simplify your system installation. Our 19" rack-mount kit provides a clean solution for mounting your I/O modules and a power supply. Or you can buy precut DIN rail strips for mounting on any flat surface.

Ordering Information

- 20RM-16-DIN
19" rack-mount kit with DIN rail.
- DIN RAIL 3.0
DIN RAIL 16.7
DIN rail strip, Type T, 3 inches (75mm) or 16.7 inches (425mm)

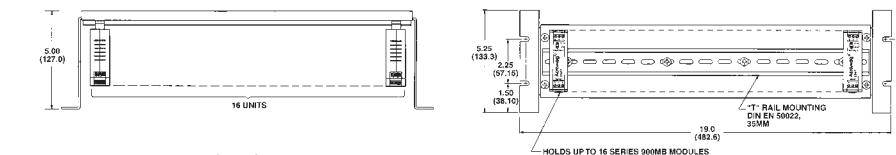

Dimensions in inches (mm).

Model 4001-095 USB-to-Serial Adapter

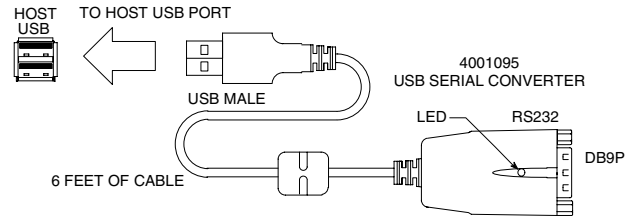
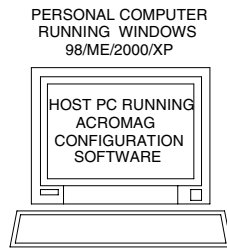

Simplifies configuration of Acromag I/O Modules ♦ Enables configuration via USB port

Description

This device is a USB-to-serial adapter that you can use to communicate with many Acromag I/O products for setup and re-configuration for your application.

Key Features & Benefits

- Connects to I/O modules via USB (other adapters may be necessary)
- Complete RS232 control signals
- Conforms to USB Specification, Version 1.1
- USB-powered
- Cable length, 6 ft., UL approved

Performance Specifications

USB Specification
Version 1.1

Data rate
Up to 115.2Kbps

Environmental Standards
RoHS-compliant

Basic Power Consumption
150mA

PC Requirements
Windows® 7 (32-/64-bit) / Vista (32-/64-bit) / XP (32-/64-bit) / Server 2003 & 2008 (32-/64-bit) / 2000 / ME / 98SE / 98

Ordering Information

NOTE: For more information visit www.acromag.com.

Adapters

- 4001-095**
USB to serial adapter. Includes driver CD and manual.
- 5030-913**
Serial port adapter. DB9S connector to RJ11 jack.
- 5034-202**
RS-485 to 3-wire cable converter and cable, DB-9M to 3 x 12AWG RS-485 cable, 8 ft.
- 5032-287**
RS-232 to 151T transmitter configuration device converter and cable, 6 ft.
- 5034-214**
Non-isolated RS-232 to RS-485 Serial Port Converter, DB-9F to DB-9F.

Cables

- 5030-902**
Cable. 6 feet long with RJ11 plug at each end.

IntelliPack 800x Series Adapter and Cable

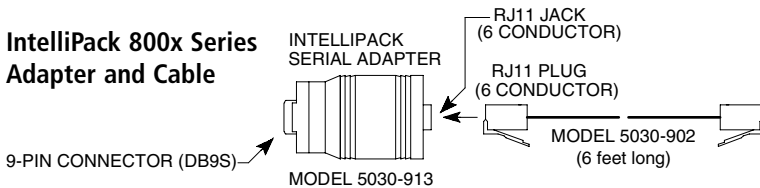

151T Transmitter Series Adapter and Cable

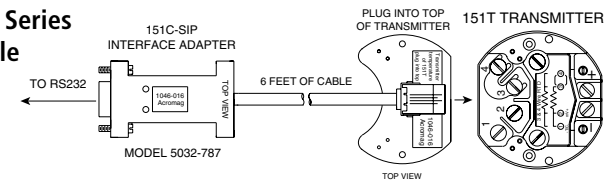

900MB Modbus Series Adapter and Cable

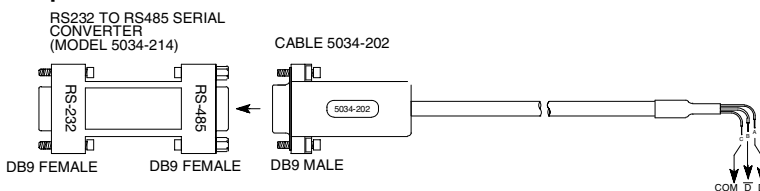

Tel: 248-295-0880 ■ Fax: 248-624-9234 ■ sales@acromag.com ■ www.acromag.com ■ 30765 S Wixom Rd, Wixom, MI 48393 USA